

RM/55401/M, Roundline cylinder

Magnetic piston, double acting

- Ø 32 ... 100 mm
- Clean line design
- Low friction, long life seals
- Standard magnetic piston for full control system versatility



Technical features

Medium:
Compressed air, filtered, lubricated or non-lubricated

Operation:
Double acting, magnetic piston, adjustable cushioning

Operating pressure:
1 ... 10 bar (14 ... 145 psi)

Cylinder diameters:
32 ... 100 mm

Strokes:
See page below

Non-standard strokes:
On request

Operating temperature:
-20°C ... +80°C (-4 ... +176°F)
Air supply must be dry enough to avoid ice formation at temperatures below +2°C (+35°F).

Materials:
Barrel and end covers: anodized aluminium
Piston rods: stainless steel (martensitic)
Piston and piston rod seals: PUR
'O'-rings: NBR

Technical data

Cylinder Ø (mm)	32	40	50	63	80	100
Port size	G 1/8	G 1/4	G 1/4	G 3/8	G 3/8	G 1/2
Piston rod Ø (mm)	12	16	20	20	25	25
Piston rod thread	M10x1,25	M12x1,25	M16x1,5	M16x1,5	M20x1,5	M20x1,5
Cushion length (mm)	19	22	24	24	27	34
Theoretical thrusts at 6 bar outstroke (N)	482	754	1178	1870	3016	4710
Theoretical thrusts at 6 bar instroke (N)	414	633	990	1680	2722	4416
Air consumption at 6 bar outstroke (l/cm)	0,056	0,088	0,137	0,218	0,35	0,55
Air consumption at 6 bar instroke (l/cm)	0,048	0,074	0,114	0,195	0,32	0,51

Standard strokes

Cylinder Ø (mm)	Strokes length (mm)								
	25	50	80	100	125	160	200	250	300
32	•	•	•	•	•	•	•	•	•
40	•	•	•	•	•	•	•	•	•
50	•	•	•	•	•	•	•	•	•
63	•	•	•	•	•	•	•	•	•
80	•	•	•	•	•	•	•	•	•
100	•	•	•	•	•	•	•	•	•

Cylinder variants

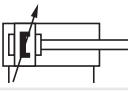
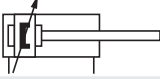
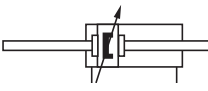
Symbol	C	S	Model magnetic piston	Description	Dimensions Page
	•	•	RM/55401/M	Standard cylinder	4
			RM/55401/W2	Cylinder with special wiper/seal (suitable for appl. with cement, plaster (stucco), arizona sand, hoar-frost or ice)	4
			RM/55401/MU	Cylinder with extended piston rod	4
			RM/55401/JM	Cylinder with double ended piston rod	4
			RM/55401/W4	Cylinder with double ended piston rod and special wiper/seal (suitable for appl. with cement, plaster (stucco), arizona sand, hoar-frost or ice)	4

For the cylinder of alternative options consult our technical service

Option selector

Piston rod material	Substitute
Stainless steel martensitic (standard)	R
Hard chromium plated	C
Stainless steel austenitic	S
Cylinder Ø (mm)	Substitute
32	33
40	41
50	51
63	64
80	81
100	11

★M/554★*/★*/★*★

Strokes (mm)	
3000 max.	
Variants (magnetic piston)	Substitute
Standard	M
Double ended piston rod	JM
Extended piston rod	MU
*M/554**/MU/***/*★	Extension (mm)

Mountings
Ø 32 ... 63 mm

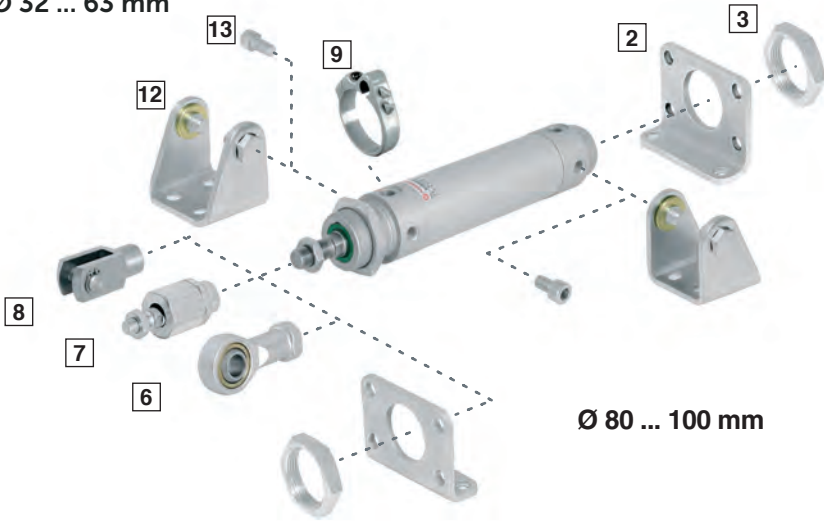

Ø 80 ... 100 mm

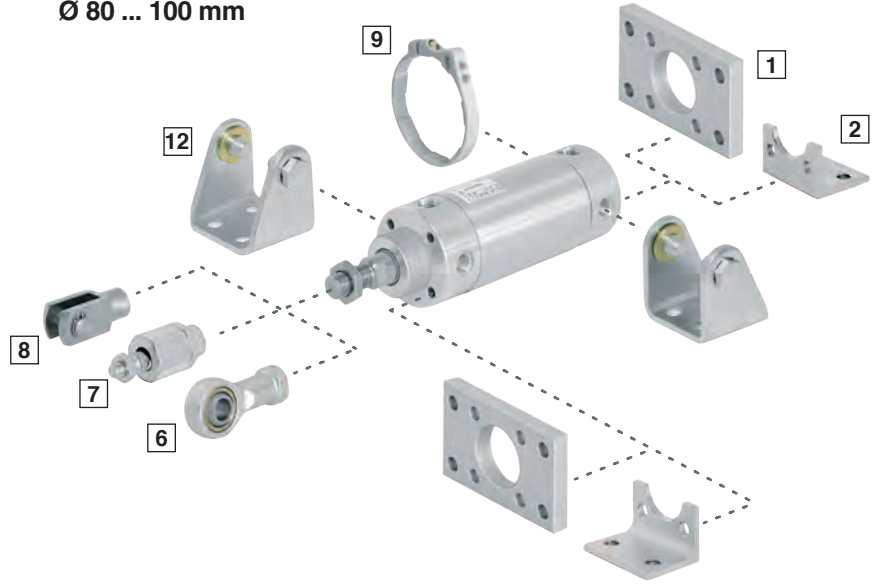

Cyl.	AK	B, G	C	F	H	L
	7	1	2	8	13	12
	Page 5	Page 5	Page 5	Page 5	Page 5	Page 5
32	QM/8025/38	QM/55232/22	QM/55232/21	QM/8025/25	QM/55232/28	QM/55232/24
40	QM/8040/38	QM/55240/22	QM/55240/21	QM/8040/25	QM/55240/28	QM/55240/24
50	QM/8050/38	QM/55250/22	QM/55250/21	QM/8050/25	QM/55250/28	QM/55250/24
63	QM/8050/38	QM/55263/22	QM/55263/21	QM/8050/25	QM/55263/28	QM/55263/24
80	QM/8080/38	QM/55480/22	QM/55480/21	QM/8080/25	QM/55480/28	QM/55480/24
100	QM/8080/38	QM/55410/22	QM/55410/21	QM/8080/25	QM/55410/28	QM/55410/24

Cyl.	N	UF	Switch mounting	Magnetically operated switches	Service kit
	3	6	9		
	Page 6	Page 6	Page 6	Page 7 & 8	
32	M/P29254	QM/8025/32	QM/33/432/22		QM/55433/00
40	M/P29255	QM/8040/32	QM/33/440/22		QM/55441/00
50	M/P29256	QM/8050/32	QM/33/450/22		QM/55451/00
63	M/P29256	QM/8050/32	QM/33/463/22		QM/55464/00
80	M/P34806	QM/8080/32	QM/33/480/22		QM/55481/00
100	M/P34806	QM/8080/32	QM/33/100/22		QM/55411/00

Basic dimensions Ø 32 ... 63 mm

Dimensions in mm
Projection/First angle

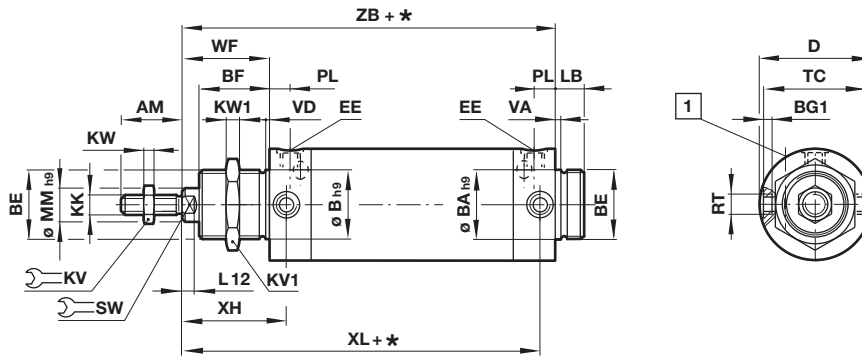

Ø 80 and 100 mm

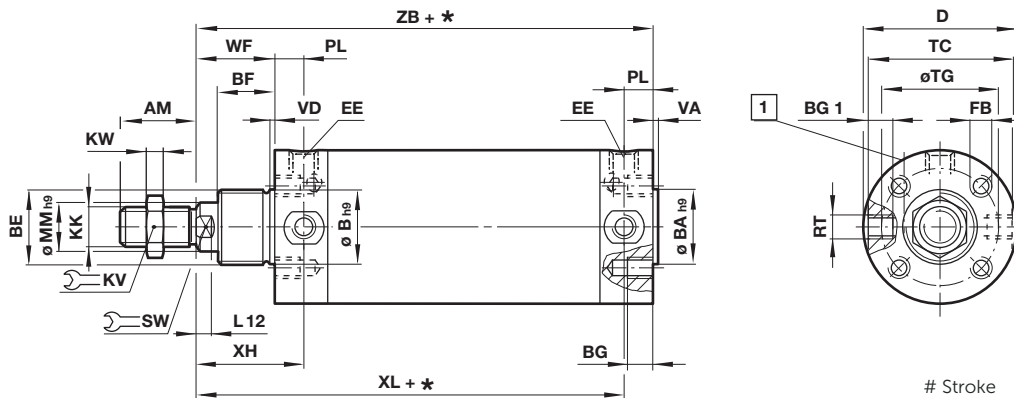

Stroke
1 Cushion screw

Ø	AM	Ø B/BA h9	BE	BF	BG	BG1	D	EE	FB	KK	KV	KV1	KW	KW1	LB
32	22	30	M 30 x 1,5	30	-	6	36,5	G 1/8	-	M 10 x 1,25	17	36	5	8	14
40	24	38	M 38 x 1,5	35	-	8	45,5	G 1/4	-	M 12 x 1,25	19	46	6	10	16
50	32	45	M 45 x 1,5	38	-	9,5	55,5	G 1/4	-	M 16 x 1,5	24	55	8	10	18
63	32	45	M 45 x 1,5	38	-	10	69,5	G 3/8	-	M 16 x 1,5	24	55	8	10	18
80	40	55	M 55 x 1,5	45	14	17,5	87,5	G 3/8	M8	M 20 x 1,5	30	-	10	-	-
100	40	55	M 55 x 1,5	45	14	21,5	107,5	G 1/2	M10	M 20 x 1,5	30	-	10	-	-
Ø	L12	Ø MM h9	PL	RT	SW	Ø TC	TG	VA/VD	WF	XH	XL	ZB	kg at 0 mm	kg per 100 mm	Model
32	5,5	12	9	M 8 x 1	10	35	-	3	38	47	123	132	0,40	0,14	RM/55433/*
40	7,5	16	12	M 10 x 1	13	44	-	3	45	57	142	154	0,83	0,27	RM/55441/*
50	8,5	20	12	M 12 x 1,5	17	54	-	3	50	62	152	164	1,30	0,32	RM/55451/*
63	8,5	20	13	M 14 x 1,5	17	67	-	3	51	64	159	172	1,60	0,38	RM/55464/*
80	11,5	25	15	M 16 x 1,5	22	85,5	70	5	61	76	196	211	3,10	0,59	RM/55481/*
100	11,5	25	18,5	M 20 x 1,5	22	105,5	80	5	61	79,5	200,5	219	4,60	0,68	RM/55411/*

* Please insert stroke length.

Cylinder variants

RM/55401/JM – Double ended piston rod

Ø	L8	ZM	Model
32	94	170	RM/55433/JM/*
40	109	199	RM/55441/JM/*
50	114	214	RM/55451/JM/*
63	121	223	RM/55461/JM/*
80	150	272	RM/55481/JM/*
100	158	280	RM/55411/JM/*

* Please insert standard stroke length.

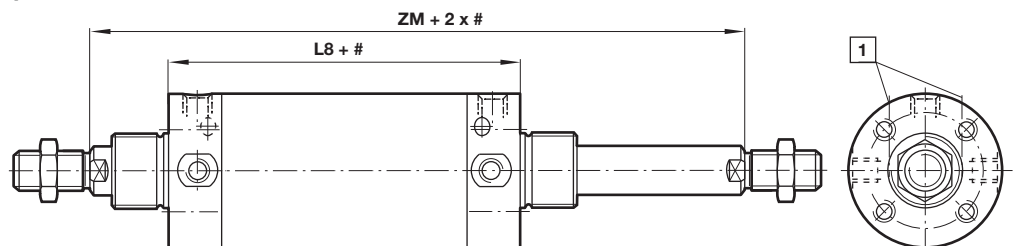

Stroke
1 Cushion screw

Mountings Piston rod swivel AK

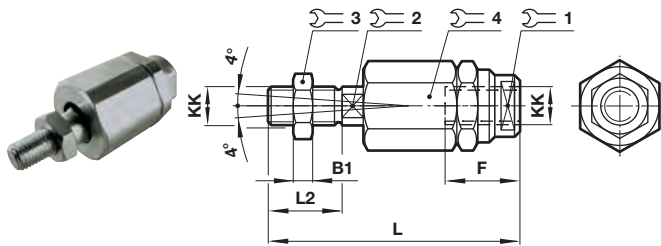

Ø	KK	B1	F	L	L2					kg	Model (AK)
						1	2	3	4		
32	M10x1,25	5	26	73	20	19	12	17	30	0,20	QM/8025/38
40	M12x1,25	6	26	77	24	19	12	19	30	0,20	QM/8040/38
50/63	M16x1,5	8	34	106	32	30	19	24	42	0,65	QM/8050/38
80/100	M20x1,5	10	42	122	40	30	19	30	42	0,72	QM/8080/38

Dimensions in mm
Projection/First angle

Rear flange B, front flange G

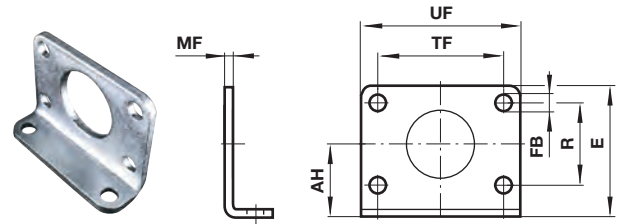

Ø	AH	E	Ø FB	MF	R	TF	UF	kg	Model
32	28	49	7	4	28	52	66	0,11	QM/55232/22
40	33	58	9	5	30	60	80	0,19	QM/55240/22
50	40	70	9	5	40	70	90	0,25	QM/55250/22
63	45	80	9	5	50	76	96	0,33	QM/55263/22
80	56	100	12	8	-	120	150	0,81	QM/55480/22
100	66	120	14	8	-	130	170	1,10	QM/55410/22

Foot C

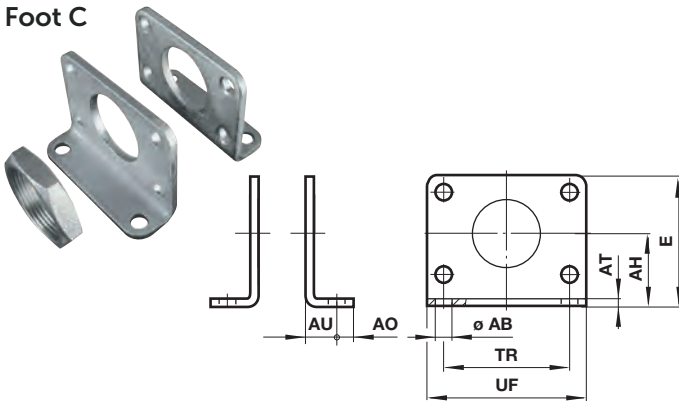

Ø	Ø AB	AH	AO	AT	AU	E	TR	UF	kg	Model
32	7	28	7	4	14	49	52	66	0,25	QM/55232/21
40	9	33	10	5	20	58	60	80	0,44	QM/55240/21
50	9	40	10	5	20	70	70	90	0,59	QM/55250/21
63	9	45	10	5	20	80	76	96	0,73	QM/55263/21
80	12	56	15	5	45	100	63	90	0,67	QM/55480/21
100	14	66	20	5	45	120	75	113	1,00	QM/55410/21

Piston rod clevis F Conforms to DIN ISO 8140

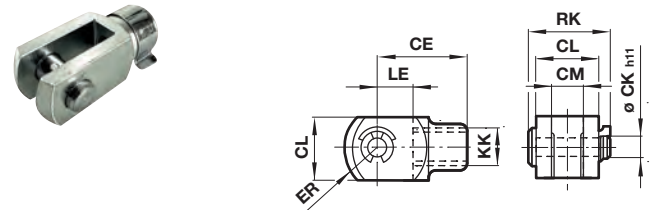

Ø	KK	CE	Ø CK h11	CL	CM	ER	LE	RK	kg	Model (F)
32	M10x1,25	40	10	20	10	16	20	28	0,09	QM/8025/25
40	M12x1,25	48	12	24	12	19	24	32	0,13	QM/8040/25
50/63	M16x1,5	64	16	32	16	25	32	41,5	0,33	QM/8050/25
80/100	M20x1,5	80	20	40	20	32	40	50	0,67	QM/8080/25

End cover trunnion H

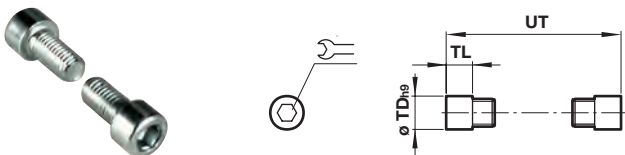

Ø	Ø TDh9	TL	UT		kg	Model
32	10	8	51	5	0,02	QM/55232/28
40	12	9,5	63	6	0,03	QM/55240/28
50	14	11	76	6	0,05	QM/55250/28
63	16	13	93	8	0,07	QM/55263/28
80	18	13	111,5	8	0,09	QM/55480/28
100	20	13	131,5	10	0,25	QM/55410/28

Rear hinge L

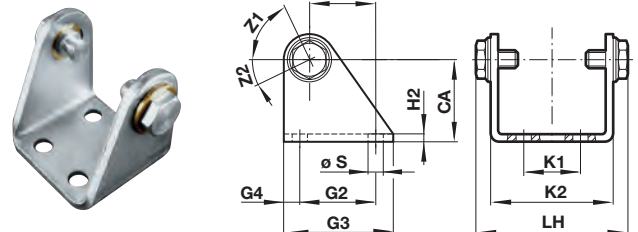

Ø	CA	G				Ø S	H2	K		LH	Z		Model
		1	2	3	4			1	2		1	2	
32	35	20	24	40	8	7	4	20	46,5	59,5	202°	36°	QM/55232/24
40	40	27	30	50	10	9	5	28	56,5	71	197°	33°	QM/55240/24
50	45	30	34	54	10	9	5	36	68,5	83	196°	31°	QM/55250/24
63	50	34	35	65	15	9	5	42	82,5	99	191°	25°	QM/55263/24
80	65	47,5	55	80	12,5	11	6	55	102,5	125,5	193°	27°	QM/55480/24
100	77	63	70	100	15	11	6	70	122,5	145,5	192°	27°	QM/55410/24

Nose nut N

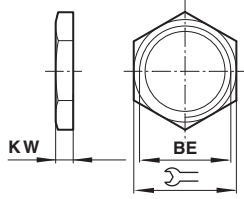

Ø	BE		KW	kg	Model
32	M30 x 1,5	36	8	0,03	M/P29254
40	M38 x 1,5	46	10	0,06	M/P29255
50/63	M45 x 1,5	55	10	0,08	M/P29256
80/100	M55 x 1,5	60	13	0,25	M/P34806

Universal piston rod eye UF Conforms to DIN ISO 8139

Dimensions in mm
Projection/First angle

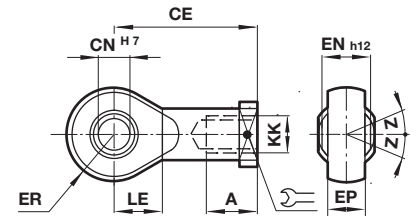

Ø	Thread KK	AX	CE	Ø CN H7	EN- 0,1	ER	LE	Z	kg	Model
32	M10x1,25	20	43	10	14	14	15	13°	0,09	QM/8025/32
40	M12x1,25	22	50	12	16	16	17	13°	0,13	QM/8040/32
50/63	M16x1,5	28	64	16	21	21	22	15°	0,33	QM/8050/32
80/100	M20x1,5	33	77	20	25	25	26	15°	0,67	QM/8080/32

Switch mounting QM/33/XXX/22

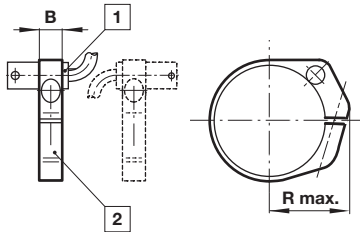

- 1 Magnetically operated switch
- 2 Switch mounting bracket

Ø	B	R max.	Model
32	10	29	QM/33/432/22
40	10	32	QM/33/440/22
50	10	38	QM/33/450/22
63	10	46	QM/33/463/22
80	12	54	QM/33/480/22
100	10	59	QM/33/100/22

Technical data - Reed switches - additional informations see data sheet N/en 4.3.005

Symbol	Voltage		Current maximum (mA)	Function	Operating temperature (°C)	LED	Protection class	Plug	Cable length (m)	Cable type	Weight (g)	Model
	(V a.c.)	(V d.c.)										
	10 ... 240	10 ... 170	180	Closer	-25 ... +80	•	IP66	—	2, 5 or 10	PVC 2 x 0,25	37	M/50/LSU/*V
	10 ... 240	10 ... 170										
	10 ... 240	10 ... 170	180	Closer	-25 ... +80	•	IP66	—	5	PUR 2 x 0,25	37	M/50/LSU/5U
	10 ... 240	10 ... 170										
	10 ... 240	10 ... 170	180	Closer	-25 ... +150	—	IP66	—	2	Silicon 2 x 0,25	37	TM/50/RAU/2S
	10 ... 240	10 ... 170	180	Changeover	-25 ... +80	—	IP66	—	5	PVC 3 x 0,25	37	M/50/RAC/5V
	10 ... 60	10 ... 60	180	Closer	-25 ... +80	•	IP66	M8 x 1	0,3	PVC 3 x 0,25	16	M/50/LSU/CP *1)

* Insert cable length; *1) Plug-in connector; Color code: BK = black, BN = brown, BU = blue

Drawings

M/50/LSU/*V, M/50/LSU/5U,
TM/50/RAU/2S
Cable length L = 2, 5 or 10 m



M/50/RAC/5V
Cable length L = 5 m



M/50/LSU/CP

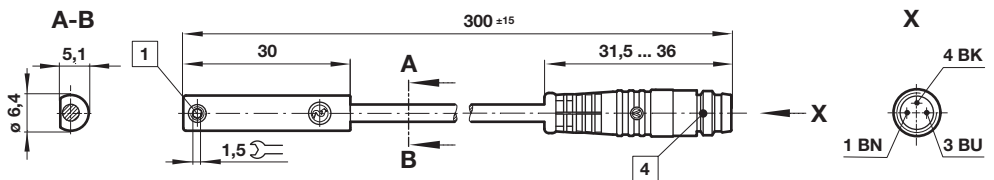
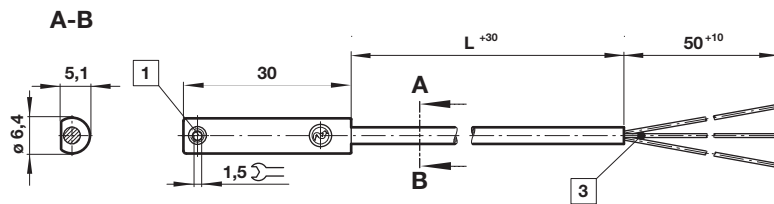
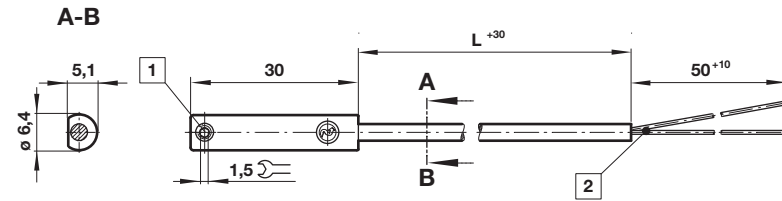

- 1 Fixing screw
- 2 + BN = brown; - BU = blue (output)
- 3 - BK = black; + BN = brown; - ≠BU = blue
- 4 Plug M8 x 1, color code: BK = black; BN = brown; BU = blue

Dimensions in mm
Projection/First angle



Technical data - Solid state - additional informations see data sheet N/en 4.3.007

Symbol	Voltage (V d.c.)	Current maximum (mA)	Function	Operating temperature (°C)	LED	Protection class	Plug	Cable length (m)	Cable type	Weight (g)	Model
	10 ... 30	150	PNP	-40 ... +80	•	IP67	—	2, 5 or 10	PVC 3 x 0,12	37	M/50/EAP/*V
	10 ... 30	150	PNP	-40 ... +80	•	IP68	—	5	PUR 3 x 0,14	37	M/50/EAP/5U
	10 ... 30	150	PNP	-40 ... +80	•	IP67	M8 x 1	0,3	PVC 3 x 0,14	16	M/50/EAP/CP *1)
	10 ... 30	150	PNP	-40 ... +80	•	IP67	M12 x 1	0,3	PVC 3 x 0,14	16	M/50/EAP/CC *1)
	10 ... 30	150	NPN	-40 ... +80	•	IP67	—	2, 5 or 10	PVC 3 x 0,12	37	M/50/EAN/*V
	10 ... 30	150	Closer	-40 ... +80	•	IP67	M8 x 1	0,3	PVC 3 x 0,14	16	M/50/EAN/CP *1)

* Insert cable length; *1) Plug-in connector; Color code: BK = black, BN = brown, BU = blue

Drawings

M/50/EAP/*V,
M/50/EAN/*V
Cable length L = 2, 5 or 10 m

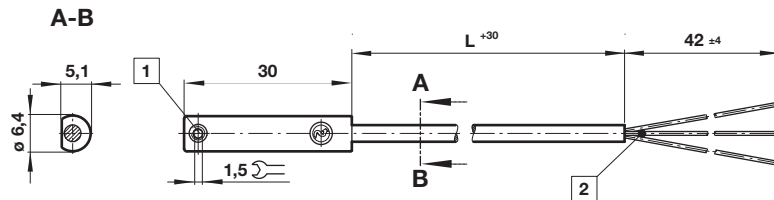

Dimensions in mm
Projection/First angle



M/50/EAP/CP,
M/50/EAN/CP

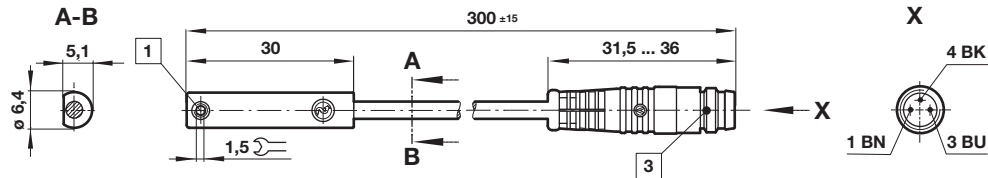

M/50/EAP/CC

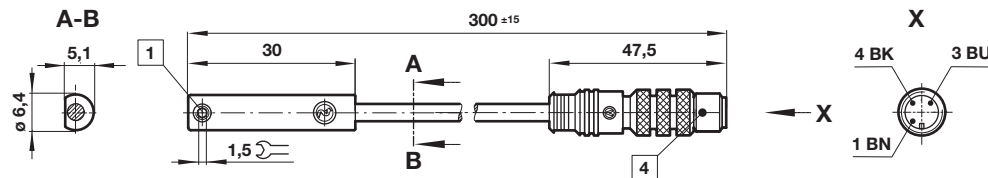

- 1 Fixing screw
- 2 Color code: BK = black; BN = brown; BU = blue
- 3 Plug M8 x 1
- 4 Plug M12 x 1

Accessories

Plug-in connector cable with nut



Outer cover	Cable length (m)	Weight (kg)	Connector	Connector
PVC 3 x 0,25	5 m	0,18	M8 x 1	M/P73001/5
PUR 3 x 0,25	5 m	0,18	M8 x 1	M/P73002/5
PUR 3 x 0,34	5 m	0,21	M12 x 1	M/P34594/5

Warning

These products are intended for use in industrial compressed air systems only. Do not use these products where pressures and temperatures can exceed those listed under »**Technical features/ data**«.

Before using these products with fluids other than those specified, for non-industrial applications, life-support systems or other applications not within published specifications, consult Norgren Ltd.

Through misuse, age, or malfunction, components used in fluid power systems can fail in various modes.

The system designer is warned to consider the failure modes of all component parts used in fluid power systems and to provide adequate safeguards to prevent personal injury or damage to equipment in the event of such failure.

System designers must provide a warning to end users in the system instructional manual if protection against a failure mode cannot be adequately provided.

System designers and end users are cautioned to review specific warnings found in instruction sheets packed and shipped with these products.