

RM/900/M, RM/900, Traditional 'Imperial' cylinder Magnetic or Non-magnetic piston, double acting

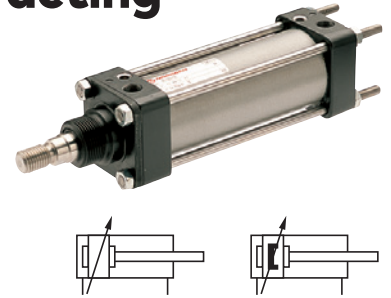

- > \varnothing 1 1/4 ... 14 inch
- > Large range of bore sizes – ideal for a wide variety of industrial applications
- > Long established design – proven ruggedness and reliability
- > Extensive choice of mountings
- > Adjustable cushioning
- > Magnetic and non-magnetic piston



Technical features

Medium:

Compressed air, filtered, lubricated or non-lubricated

Operation:

RM/900: Double acting, adjustable cushioning
RM/900/M: Double acting, adjustable cushioning and magnetic piston (\varnothing 1 1/4 ... 4" only)

Operating pressure:

1 ... 10 bar (14 ... 145 psi)

Port size:

G1/8 ... G1

Cylinder diameters:

1 1/4, 1 3/4, 2, 2 1/2, 3, 4, 5, 6, 8, 10, 12 or 14"

Strokes:

See page below

Non-standard strokes:

Available, 15 x cylinder \varnothing maximum

Operating temperature:

-20 ... +80°C max. (-4 ... +176 °F)
Air supply must be dry enough to avoid ice formation at temperatures below +2°C (+35°F).

Materials:

Barrel: anodized aluminium except \varnothing 10", 12", 14" inch which is steel
End cover: diecast aluminium
Bearing housing: brass for 1 1/4 inch to 3 inch (\varnothing 4 inch to 14 inch aluminium)
Piston: aluminium
Piston rod and tie rods: stainless steel (Martensitic)
Seals: NBR
O-rings: NBR

Technical data

Cylinder \varnothing (inch)	1 1/4	1 3/4	2	2 1/2	3	4	5	6	8	10	12	14
Port size	G 1/8	G 1/4	G 1/4	G 3/8	G 3/8	G 3/8	G 1/2	G 1/2	G 3/4	G 1	G 1	G 1
Piston rod \varnothing (mm)	12	16	20	25	25	32	1 1/2	1 1/2	1 3/4	2 1/4	2 1/4	2 1/4
Piston rod thread	M10 x 1,5	M12 x 1,75	M16 x 2	M22 x 2,5	M22 x 2,5	M24 x 3	M30 x 3,5	M30 x 3,5	M36 x 4	M48 x 5	M48 x 5	M48 x 5
Cushion length (mm)	20	20	20	21	29	38	29	32	44	50	50	50
Initial cushion volume (cm ³)	12	25	29	48	109	265	315	538	1428	2754	4257	6725
Theoretical thrusts at 6 bar outstroke (N)	482	933	1225	1930	2721	4902	7600	10887	19419	30402	43837	59723
Theoretical thrusts at 6 bar instroke (N)	406	812	1055	1626	2417	4420	6920	10207	18486	28871	42306	58192
Air consumption at 6 bar outstroke (l/cm)	0,056	0,109	0,143	0,225	0,318	0,572	0,887	1,270	2,266	3,547	5,114	6,968
Air consumption at 6 bar instroke (l/cm)	0,047	0,095	0,124	0,190	0,282	0,516	0,807	1,191	2,157	3,368	4,936	6,789

Standard strokes

Cylinder \varnothing (inch)	Stroke length (mm)		100	150	200	225	250	300
	50	75						
1 1/4	•	•	•	•	•	•	•	•
1 3/4	•	•	•	•	•	•	•	•
2	•	•	•	•	•	•	•	•
2 1/2	•	•	•	•	•	•	•	•
3	•	•	•	•	•	•	•	•
4	•	•	•	•	•	•	•	•
5	•	•	•	•	•	•	•	•
6	•	•	•	•	•	•	•	•
8	•	•	•	•	•	•	•	•
10	•	•	•	•	•	•	•	•
12	•	•	•	•	•	•	•	•
14	•	•	•	•	•	•	•	•

Cylinder variants

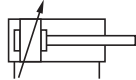
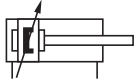
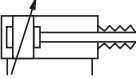
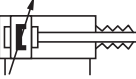
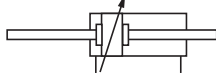
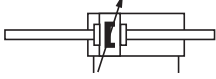
Symbol	Model Non-magnetic piston		Symbol	Model magnetic piston		Description	Dimensions	
	H	S		H	S			Page
	•	•		•	•	RM/900/M	Standard cylinder	4
	•	•		•	•	RM/900/MX	Female piston rod thread	5
	•	•		•	•	RM/900/MY	Full piston rod thread	5
		•			•	RM/900/MG	Cylinder with piston rod bellows	6
	•	•		•	•	RM/900/JM	Cylinder with double ended piston rod	5

Option selector

Non-standard variants	Substitute
High temperature version 150°C max.	T
Piston rod material	Substitute
Stainless steel martensitic	R
Stainless steel austenitic	S
Cylinder ø (inch)	Substitute
1 1/4	125
1 3/4	175
2	20
2 1/2	25
3	30
4	40
5	50
6	60
8	80
10	100
12	120
14	140

★★M/9★★★/★★/★★★

Strokes (mm)	
2500 maximum	
Variants (ø 1 1/4 ... 14" (non-magnetic piston))	Substitute
Standard	None
Female piston rod thread	X
Full piston rod thread	Y
Piston rod bellow	G
Double ended piston rod	J
Variants (ø 1 1/4 ... 4" (magnetic piston))	Substitute
Standard	M
Female piston rod thread	MX
Full piston rod thread	MY
Piston rod bellow	MG
Double ended piston rod	JM

Note: If option is not required, disregard option position within part number eg. RM/920/M/100.

For combinations of cylinder variants consult our technical service. Please note that heat resistant seals are not available for all variants. This options selector explains only the cylinder variants.

Additional variants/options are not possible.





Mountings and service kit

Model	B	B & G	C	D	F	G	H	K
								
Cyl. ø	Page 6	Page 6	Page 7	Page 8	Page 10	Page 6	Page 9	Page 8
1 1/4	M/P6938	QM/819	QM/754	M/P6937	QM/402	M/P6938	M/P14001	M/P6937
1 3/4	QM/888	QM/1181	QM/753	M/P7457	QM/404	QM/986	M/P11224	M/P7457
2	QM/875	QM/1182	QM/752	M/P10228	QM/405	QM/871	M/P8635	QM/962
2 1/2	QM/876	QM/1184	QM/748	M/P10311	QM/407	QM/877	M/P8636	QM/964
3	QM/878	QM/1185	QM/983	M/P10229	QM/407	QM/984	M/P8637	QM/966
4	QM/887	QM/1187	QM/982	QM/758	QM/408	QM/987	M/P8638	QM/758
5	QM/886	QM/1188	QM/981	QM/759	QM/409	QM/988	M/P8639	QM/759
6	QM/884	QM/1189	QM/826	QM/761	QM/409	QM/884	M/P8640	QM/761
8	QM/883	QM/1190	QM/825	QM/762	QM/410	QM/883	M/P8645	QM/762
10	QM/882	-	QM/824	-	QM/411	QM/882	M/P8667	-
12	QM/889	-	QM/756	-	QM/411	QM/889	M/P8670	-
14	QM/741	-	QM/755	-	QM/411	QM/741	M/P11819	-

Model	L	M	N	R	UF	UH	UR	Service kit
								
Cyl. ø	Page 8	Page 9	Page 8	Page 10	Page 11	Page 10	Page 11	Page 12
1 1/4	QM/394	QM/393	M/P11716	M/P11966	QM/1141	QM/9125/40	QM/1161	QM/9125/00
1 3/4	QM/922	QM/923	M/P7955	M/P11219	QM/1142	QM/9175/40	QM/1162	QM/9175/00
2	QM/909	QM/908	M/P9969	M/P10349	QM/1143	QM/920/40	QM/1163	QM/920/00
2 1/2	QM/910	QM/901	M/P9905	M/P10351	QM/1144	QM/925/40	QM/1164	QM/925/00
3	QM/911	QM/901	M/P9905	M/P10353	QM/1144	QM/930/40	QM/1165	QM/930/00
4	QM/912	QM/902	QM/1475*	QM/763	QM/1146	QM/940/40	QM/1166	QM/940/00
5	QM/913	QM/903	QM/997*	QM/764	-	-	QM/950/33	QM/950/00
6	QM/914	QM/903	QM/997*	QM/765	-	-	QM/960/33	QM/960/00
8	QM/915	QM/904	-	QM/766	-	-	QM/980/33	QM/980/00
10	QM/917	QM/919	-	QM/767	-	-	-	QM/9100/00
12	QM/918	QM/919	-	QM/768	-	-	-	QM/9120/00
14	QM/924	QM/919	-	QM/769	-	-	-	QM/9140/00

Accessories

Magnetically operated switches

Model	M/50/**	Switch mounting brackets for M/50	TQM/31, QM/32, QM/132	Switch mounting brackets for TQM/31, QM/32, QM/132
				
Cyl. ø	Page 12 & 13	23 Page 13	Page 14	Page 15
1 1/4		QM/27/2/1		QM/31/032/22
1 3/4		QM/27/2/1		QM/31/032/22
2		QM/27/2/1		QM/31/032/22
2 1/2		QM/27/2/1		QM/31/032/22
3		QM/27/2/1		QM/31/080/22
4		QM/27/2/1		QM/31/080/22

Cylinder variants
RM/900/X, RM/900/MX – Cylinder with piston rod style 'X'

 Dimensions in mm
 Projection/First angle

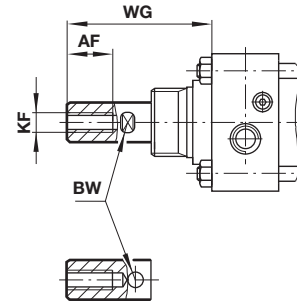

ø inch	AF	 BW	KF	WG	Model non-magnetic piston	Model magnetic piston
1 1/4	14	10	M 10	50,5	RM/9125/X/*	RM/9125/MX/*
1 3/4	14	12	M 10	54,5	RM/9175/X/*	RM/9175/MX/*
2	19	17	M 12	64,5	RM/920/X/*	RM/920/MX/*
2 1/2	29	22	M 18	84,5	RM/925/X/*	RM/925/MX/*
3	29	22	M 18	89,5	RM/930/X/*	RM/930/MX/*
4	38	27	M 24	105	RM/940/X/*	RM/940/MX/*
5	48	Ø10	M 30	133,5	RM/950/X/*	
6	48	Ø10	M 30	133,5	RM/960/X/*	
8	57	Ø10	M 30	149,5	RM/980/X/*	
10	76	Ø10	M 42	191,5	RM/9100/X/*	
12	76	Ø10	M 42	191,5	RM/9120/X/*	
14	76	Ø10	M 42	210,5	RM/9140/X/*	

* Please insert standard stroke length.

RM/900/Y, RM/900/MY – Cylinder with piston rod style 'Y'

ø inch	AA	 BW	KM	WD	Model non-magnetic piston	Model magnetic piston
1 1/4	29,5	10	M 12	39,5	RM/9125/Y/*	RM/9125/MY/*
1 3/4	35,5	12	M 16	41	RM/9175/Y/*	RM/9175/MY/*
2	43	17	M 18	56,5	RM/920/Y/*	RM/920/MY/*
2 1/2	58	22	M 24	55	RM/925/Y/*	RM/925/MY/*
3	58	22	M 24	60	RM/930/Y/*	RM/930/MY/*
4	73	27	M 30	67	RM/940/Y/*	RM/940/MY/*
5	88	Ø10	M 36	87	RM/950/Y/*	
6	88	Ø10	M 36	87	RM/960/Y/*	
8	103	Ø10	M 42	91	RM/980/Y/*	
10	134	Ø10	M 56	111,5	RM/9100/Y/*	
12	134	Ø10	M 56	111,5	RM/9120/Y/*	
14	134	Ø10	M 56	130,5	RM/9140/Y/*	

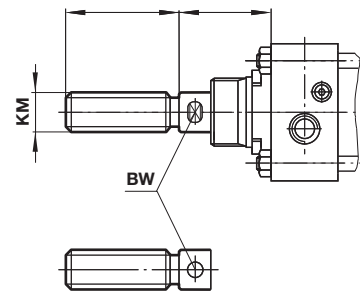
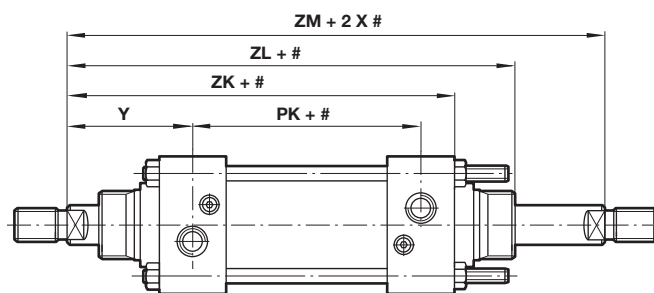
* Please insert standard stroke length.



RM/900/J, RM/900/JM – Cylinder with double ended piston rod

Stroke

ø inch	PK	ZK	ZL	ZM	Y	at 0 mm	per 25 mm	Model non-magnetic piston	Model magnetic piston
1 1/4	66,5	128,5	155,5	165,5	49,5	0,65 kg	0,08 kg	RM/9125/J/*	RM/9125/JM/*
1 3/4	69,5	136,5	163,5	173,5	52	1,21 kg	0,13 kg	RM/9175/J/*	RM/9175/JM/*
2	67	142,5	172	187,5	60,5	1,66 kg	0,19 kg	RM/920/J/*	RM/920/JM/*
2 1/2	72,5	157	190,5	210	68,5	2,82 kg	0,27 kg	RM/925/J/*	RM/925/JM/*
3	95	179,5	218	237	71	3,86 kg	0,30 kg	RM/930/J/*	RM/930/JM/*
4	96,5	187,5	232	251,5	77,5	5,31 kg	0,41 kg	RM/940/J/*	RM/940/JM/*
5	109	228,5	292	311,5	101	11,85 kg	0,77 kg	RM/950/J/*	
6	115,5	235	298,5	318	101	15,60 kg	1,20 kg	RM/960/J/*	
8	145,5	276	339,5	362	108,5	26,91 kg	1,30 kg	RM/980/J/*	
10	173,5	343	419	452	139,5	81,10 kg	2,39 kg	RM/9100/J/*	
12	173,5	343	419	452	139,5	105,30 kg	2,59 kg	RM/9120/J/*	
14	187,5	366,5	462	494,5	153,5	109,00 kg	3,30 kg	RM/9140/J/*	

* Please insert standard stroke length.

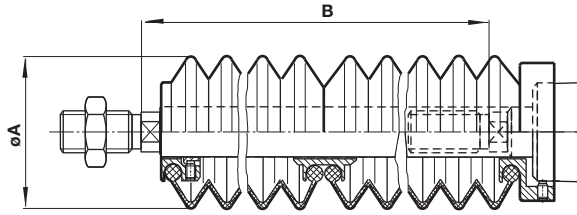
RM/900/G, RM/900/MG – Piston rod bellow

 Dimensions in mm
 Projection/First angle

Ø inch	Ø A	Max. stroke per bellow	Piston rod extension B		Model non-magnetic piston	Model magnetic piston
			for first bellow	for further bellow		
1 1/4	40	60	30	25	RM/9125/G/*	RM/9125/MG/*
1 3/4	63	145	50	32	RM/9175/G/*	RM/9175/MG/*
2	63	145	40	32	RM/920/G/*	RM/920/MG/*
2 1/2	80	250	50	45	RM/925/G/*	RM/925/MG/*
3	80	250	50	45	RM/930/G/*	RM/930/MG/*
4	80	250	50	45	RM/940/G/*	RM/940/MG/*
5	116	350	70	60	RM/950/G/*	
6	116	350	70	60	RM/960/G/*	
8	116	350	70	60	RM/980/G/*	
10	143	500	110	100	RM/9100/G/*	

* Please insert standard stroke length.

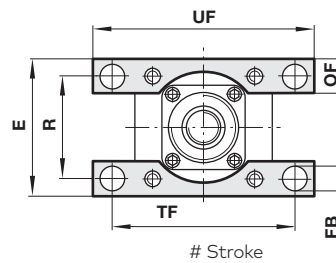
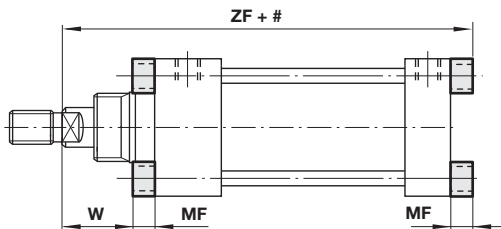
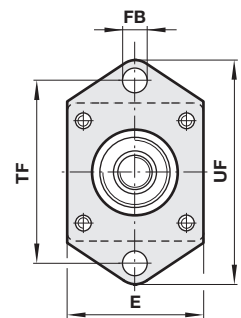
Mountings
Front flange – B or G
Front and rear flange – BG

For 9125 only

Ø inch	E	FB	MF	OF	R	TF	UF	W	ZF	Weight	Model B	Model BG	Model G
1 1/4	45	8	9,5	-	-	63,5	79	27,5	135	0,15 kg	M/P6938	QM/819	M/P6938
1 3/4	59	9	10	16	43	81	98,5	27	142,5	0,20 kg	QM/888	QM/1181	QM/986
2	64	9	10	16	47,5	85,5	105	35,5	147	0,20 kg	QM/875	QM/1182	QM/871
2 1/2	75,5	9	10	20	55,5	93,5	113	43	162,5	0,25 kg	QM/876	QM/1184	QM/877
3	88,5	11,5	16	22	66,5	111	133,5	41,5	195,5	0,45 kg	QM/878	QM/1185	QM/984
4	121	14	16	32	89	146	178	48	203,5	1,00 kg	QM/887	QM/1187	QM/987
5	148	14,5	20	40	108	171,5	203	63	248,5	1,50 kg	QM/886	QM/1188	QM/988
6	168,5	18	20	40	128,5	205	243	63	255	2,40 kg	QM/884	QM/1189	QM/884
8	218,5	22	25	50	168	263,5	314,5	61	301	5,50 kg	QM/883	QM/1190	QM/883
10	274,5	26	30	65	209,5	333,5	397	79	373	12,00 kg	QM/882	-	QM/882
12	311	26	30	65	246	384	448	79	373	14,00 kg	QM/889	-	QM/889
14	368	33	38	76	292	457	533	90	405	23,00 kg	QM/741	-	QM/741

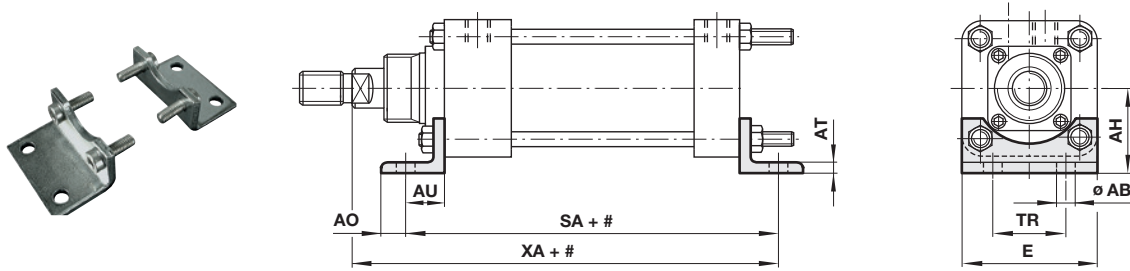
Foot mounting – C

 Dimensions in mm
 Projection/First angle

Stroke

Ø inch	Ø AB	AH	AO	AT	AU	E	SA	TR	XA	Weight	Model
1 1/4	6,8	24	6,5	6,5	14,5	45	117	-	139,5	0,06 kg	QM/754
1 3/4	10,5	37,5	11	5	19	57	133,5	-	151,5	0,20 kg	QM/753
2	13	40	11	5	19	63	129,5	-	156	0,20 kg	QM/752
2 1/2	13	46,5	11	5	19	74	137,5	30	171,5	0,25 kg	QM/748
3	13	52,5	11	5	19	91	160	28,5	198,5	0,30 kg	QM/983
4	13,5	70	24,5	8	25,5	114	174	51	212,5	0,65 kg	QM/982
5	17,5	82,5	21,5	8	28,5	140	202,5	57	257	1,00 kg	QM/981
6	17,5	99,5	25	10	35	167	222	70	270	2,50 kg	QM/826
8	17,5	122	22	10	38	219	266	82,5	314	3,50 kg	QM/825
10	26	159	46	15	54	270	341,5	114,5	397	8,00 kg	QM/824
12	26	177	46	15	54	320	341,5	139,5	397	9,50 kg	QM/756
14	33,5	212,5	33,5	15	66,5	375	372	159	433,5	20,50 kg	QM/755

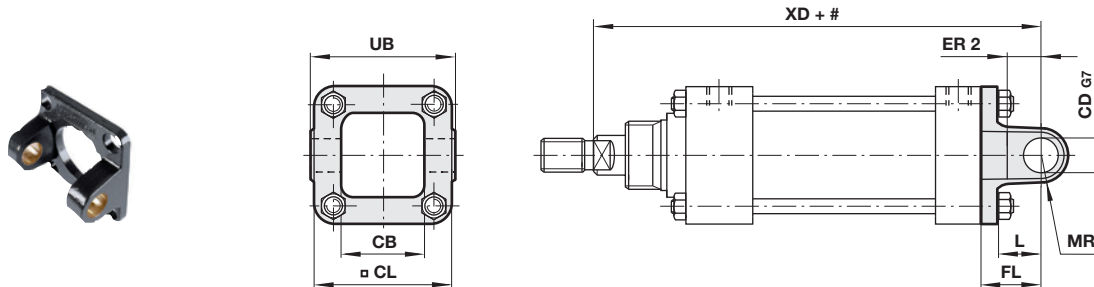
Rear clevis – D

Stroke

Ø inch	CB	Ø CD G7	CL	ER 2	FL	L	MR	UB	XD	Weight	Model
1 1/4	25,4	6	44,5	9,5	14,5	9,5	6,5	-	139,5	0,08 kg	M/P6937
1 3/4	34,9	12	57	14,5	19	14,5	10	-	151,5	0,15 kg	M/P7457
2	34,9	16	62,5	20,5	28,5	20,5	13	-	165,5	0,25 kg	M/P10228
2 1/2	42,9	16	74	20,5	28,5	20,5	13	-	181	0,25 kg	M/P10311
3	44,5	20	88	25,5	35	25,5	14	-	214,5	0,75 kg	M/P10229
4	69,9	22	114,5	36,5	57	38	19	122,5	244,5	1,25 kg	QM/758
5	92,1	25	139,5	32	70	44,5	24	152,5	298,5	2,50 kg	QM/759
6	106,4	32	166,5	35	76	49	29	181	311	3,50 kg	QM/761
8	122,2	38	217,5	38	85,5	57	38	237	362	7,00 kg	QM/762

Front clevis – K

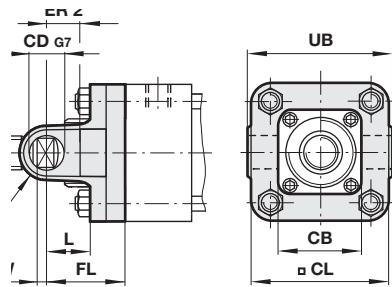

Dimensions in mm
Projection/First angle



Ø inch	CB	Ø CD G7	CL	ER 2	FL	L	MR	UB	XW	Weight	Model
11/4	25,4	6	44,5	9,5	14,5	9,5	6,5	–	22,5	0,08 kg	M/P6937
13/4	34,9	12	57	14,5	19	14,5	10	–	18	0,15 kg	M/P7457
2	34,9	16	62,5	20,5	28,5	20,5	13	–	7,5	0,25 kg	QM/962
2 1/2	42,9	16	74	20,5	28,5	20,5	13	–	16,5	0,25 kg	QM/964
3	44,5	20	88	25,5	35	25,5	14	–	6,5	0,75 kg	QM/966
4	69,9	22	114,5	36,5	57	38	19	122,5	7	1,25 kg	QM/758
5	92,1	25	139,5	32	70	44,5	24	152,5	13	2,50 kg	QM/759
6	106,4	32	166,5	35	76	49	29	181	6,5	3,50 kg	QM/761
8	122,2	38	217,5	38	85,5	57	38	237	0	7,00 kg	QM/762

Nose mounting – N

Ø inch	KV	KW	Weight	Model
11/4	28	6,5	0,02 kg	M/P11716
13/4	38	8	0,04 kg	M/P7955
2	43	8	0,04 kg	M/P9969
2 1/2	48	8	0,04 kg	M/P9905
3	48	8	0,04 kg	M/P9905
4	57	8	0,06 kg	QM/1475*
5	70	12,5	0,18 kg	QM/997*
6	70	12,5	0,18 kg	QM/997*

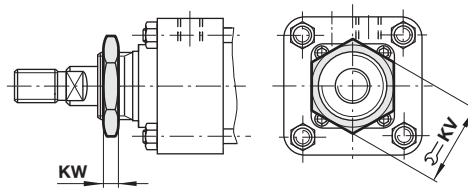

* These cannot be supplied separately. If a spare Nose Mounting is required, specify basic cylinder reference with 'Q' prefix and -/06 suffix, e.g. QM/950/N/06

Rear hinge mounting – L

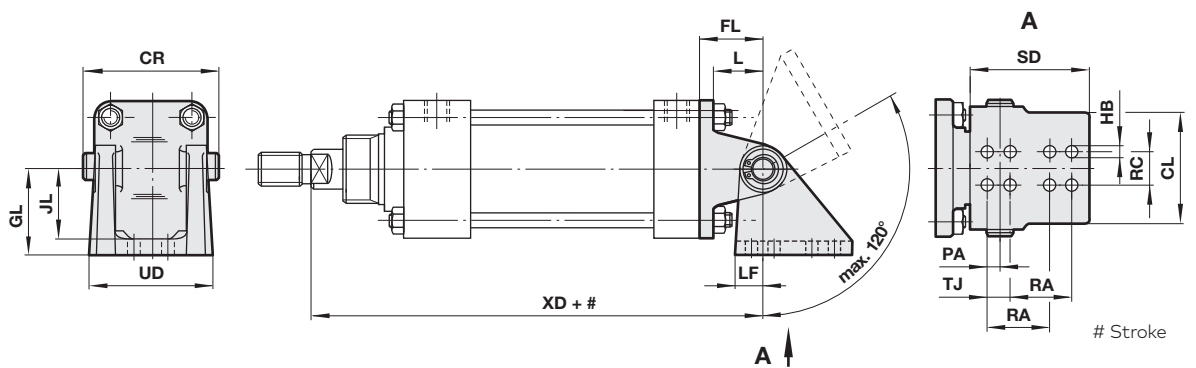

Ø inch	CL	CR	FL	GL	Ø HB	JL	L	LF	PA	RA	RC	SD	TJ	UD	XD	Weight	Model
11/4	31	39,5	25,5	28,5	7,2	20,5	19	9,5	1,5	25,5	–	41,5	–	–	151	0,25 kg	QM/394
13/4	32	44,5	32	32	8,7	25,5	24	13	5	32	–	47,5	–	–	164,5	1,10 kg	QM/922
2	60	73	35	47,5	8,5	39,5	25,5	15,5	6,5	47,5	19	66,5	–	68,5	172	1,20 kg	QM/909
2 1/2	60	73	35	47,5	8,5	39,5	25,5	15,5	6,5	47,5	19	66,5	–	68,5	187,5	1,25 kg	QM/910
3	60	73	35	47,5	8,5	39,5	25,5	15,5	6,5	47,5	19	66,5	–	68,5	214,5	1,50 kg	QM/911
4	70	82,5	51	74,5	12	65	30	23,5	11	76	22	101,5	–	82,5	238	3,50 kg	QM/912
5	70	82,5	57	74,5	12	65	33,5	23,5	11	76	22	101,5	–	82,5	285,5	5,00 kg	QM/913
6	98,5	114,5	70	89	13,5	76	43	28	12,5	101,5	32	165	32	108	305	11,00 kg	QM/914
8	100	114,5	79,5	116	16,7	100	47,5	31,5	16	114,5	32	184	38	117,5	355,5	17,50 kg	QM/915
10	151	178	95,5	171,5	27	151	57	44,5	16	133,5	51	247,5	57	159	438	25,00 kg	QM/917
12	151	178	95,5	171,5	27	151	57	44,5	16	133,5	51	247,5	57	159	438	30,00 kg	QM/918
14	210	239	120,5	232	27	209,5	73	63,5	28,5	139,5	63,5	279,5	70	210	487,5	61,00 kg	QM/924

Front hinge mounting – M

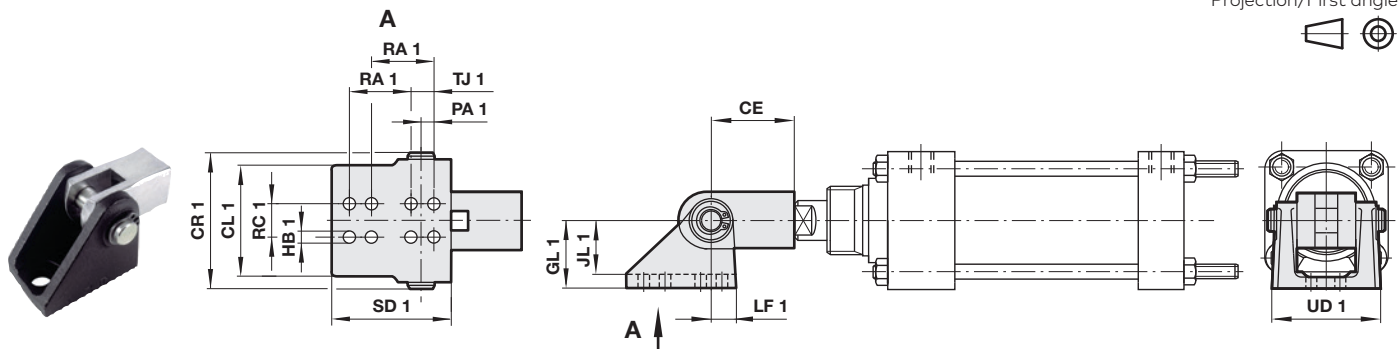
 Dimensions in mm
 Projection/First angle

Ø inch	CE	CL1	CR1	GL1	Ø HB1	JL1	LF1	PA1	RA1	RC1	SD1	TJ1	UD1	Weight	Model
1 1/4	25,5	31	39,5	28,5	7,2	20,5	9,5	1,5	25,5	-	41,5	-	-	0,17 kg	QM/393
1 3/4	33,5	32	44,5	32	8,7	25,5	13	5	32	-	47,5	-	-	0,30 kg	QM/923
2	41,5	43	54	32	8,5	24	14	5	32	-	51	-	49	0,40 kg	QM/908
2 1/2	58,5	60	73	47,5	8,5	39,5	16	6,5	47,5	19	67	-	68,5	1,00 kg	QM/901
3	58,5	60	73	47,5	8,5	39,5	16	6,5	47,5	19	67	-	68,5	1,00 kg	QM/901
4	66,5	70	82,5	74,5	12	65	24	11	76	22	102	-	82,5	2,00 kg	QM/902
5	79,5	79,5	92	89	10,3	79,5	28,5	16	89	22	114,5	-	-	3,00 kg	QM/903
6	79,5	79,5	92	89	10,3	79,5	28,5	16	89	22	114,5	32	-	3,00 kg	QM/903
8	95,5	98,5	114,5	89	13,5	76	28,5	12,5	102	32	165	32	108	6,00 kg	QM/904
10	120,5	124	139,5	116	20	100	35	12,5	120,5	38	206,5	41,5	-	9,00 kg	QM/919
12	120,5	124	139,5	116	20	100	35	12,5	120,5	38	206,5	41,5	-	9,00 kg	QM/919
14	120,5	124	139,5	116	20	100	35	12,5	120,5	38	206,5	41,5	-	10,50 kg	QM/919

Centre trunnion – H

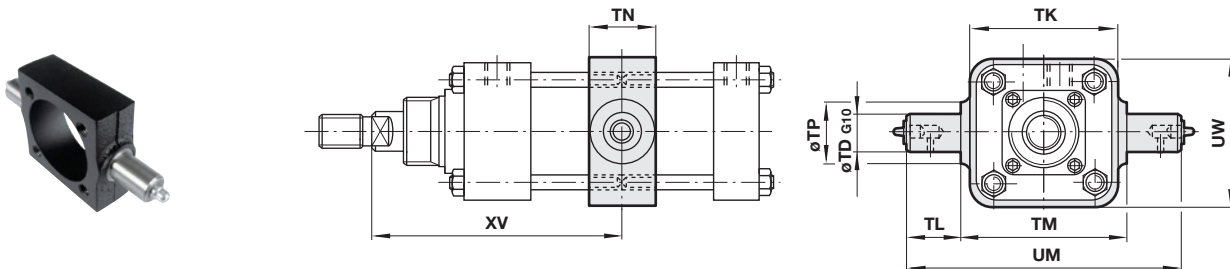

Ø inch	Ø TD g10	TK	TL	TM	TN	Ø TP	UM	UW	XV min	XV max	Weight	Model
1 1/4	12	45	17,5	50,5	20,5	18	85,5	45	72,5	93	0,16 kg	M/P14001
1 3/4	16	65	24	73	25,5	22	120,5	65	79	94,5	0,50 kg	M/P11224
2	18	70	25,5	79,5	32	29	130	70	90,5	97	0,60 kg	M/P8635
2 1/2	22	81	32	90,5	38	35	154	81	102	108,5	0,90 kg	M/P8636
3	25	95	38	108	38	38	184	95	111,5	125,5	1,25 kg	M/P8637
4	32	127	41,5	139,5	44,5	44,5	222,5	127	121,5	130	2,50 kg	M/P8638
5	38	152	51	165	51	51	266,5	152	149,5	162	3,50 kg	M/P8639
6	38	187	51	192	51	51	293,5	187	149,5	168,5	5,00 kg	M/P8640
8	45	241,5	54	247,5	70	64	355,5	245	173	189	10,00 kg	M/P8645
10	65	330	76	330	76	114	482,5	318	207	245	25,00 kg	M/P8667
12	75	381	76	381	89	127	533,5	368	213,5	238,5	35,00 kg	M/P8670
14	90	457	101,5	457	101,5	140	660,5	432	239	255,5	51,50 kg	M/P11819

Note: These mountings are only supplied assembled complete with the cylinder. Unless otherwise specified, units will be supplied with dimension 'XV' plus half the stroke length. Grease nipple supplied as standard on cylinders 9175 to 9140.

Adjustable trunnion mounting – UH

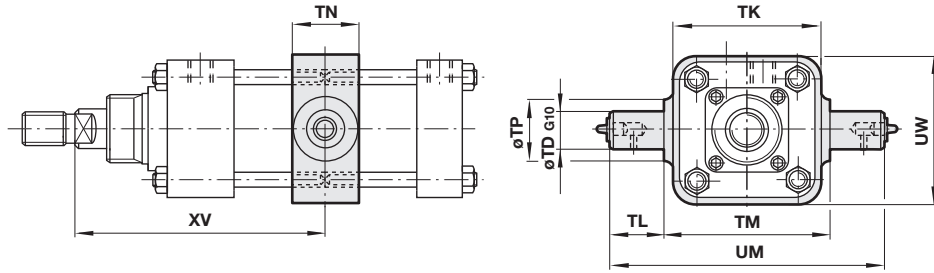
 Dimensions in mm
 Projection/First angle

Ø inch	ØTD G10	ØTP	TL	TM	TN	UM	UV	UW 1	XV min	XV max	Torque (Nm)	Weight	Model
1 1/4	12	18	17,5	50,5	20,5	85,5	45	60	72,5	93	4	0,24 kg	QM/9125/40
1 3/4	16	22	24	73	25,5	120,5	57	74	79	94,5	8	0,43 kg	QM/9175/40
2	18	29	25,5	79,5	32	130	70	87	90,5	97	8	0,70 kg	QM/920/40
2 1/2	22	35	32	90,5	38	154	81	95	102	108,5	8	1,14 kg	QM/925/40
3	25	38	38	108	38	184	95	110	111,5	125,5	10	1,30 kg	QM/930/40
4	32	44,5	41,5	139,5	44,5	222,5	127	131	121,5	130	10	2,32 kg	QM/940/40

Note: It is most important that the locking screws which secure the mounting to the tie rod are tightened to the torque figures shown in the above table. For maximum energy input, consult our Technical Service.

Unless otherwise specified, units will be supplied with dimension 'XV' plus half the stroke length. 'XV' = Distance from the piston rod shoulder to the centre of the mounting.

Piston rod clevis – F

Ø inch	CE	CL	CM	CR	ØEK G10	ER	LE	Weight	Model
1 1/4	25,5	12,5	6,4	18	6	6,5	11	0,03 kg	QM/402
1 3/4	33,5	19	10	26	10	10	12,5	0,05 kg	QM/404
2	41,5	25,5	11	33	12	13	19	0,10 kg	QM/405
2 1/2	58,5	38	14	47	16	19	25,5	0,40 kg	QM/407
3	58,5	38	14	47	16	19	25,5	0,40 kg	QM/407
4	66,5	44,5	16	53	18	22	28,5	0,90 kg	QM/408
5	79,5	51	20	60	22	25	32	1,25 kg	QM/409
6	79,5	51	20	60	22	25	32	1,25 kg	QM/409
8	95,5	63,5	25	74	25	32	38	1,70 kg	QM/410
10	120,5	76	32	87	32	38	44,5	2,75 kg	QM/411
12	120,5	76	32	87	32	38	44,5	2,75 kg	QM/411
14	120,5	76	32	87	32	38	44,5	4,50 kg	QM/411

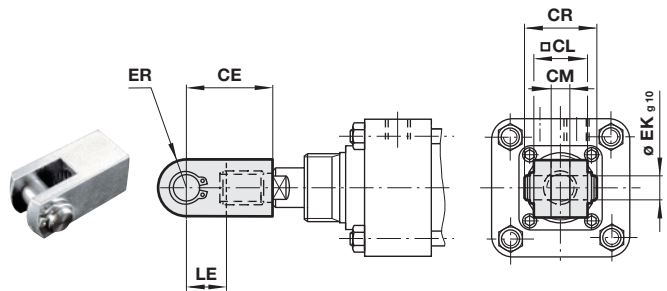

Rear eye – R

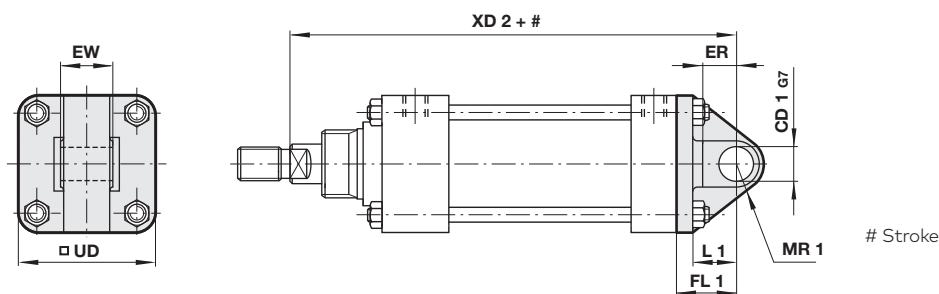

Ø inch	ØCD 1 G7	ER	EW	FL 1	L 1	MR 1	UD	XD 2	Weight	Model
1 1/4	6	19	19	25,5	19	9	45	151	0,10 kg	M/P11966
1 3/4	10	14,5	19	32	24	10	57	164,5	0,26 kg	M/P11219
2	16	19	38,1	35	25,5	14	62	172	0,55 kg	M/P10349
2 1/2	16	19	38,1	35	25,5	14	74	187,5	0,80 kg	M/P10351
3	16	19	38,1	35	25,5	16	87,5	214,5	0,90 kg	M/P10353
4	18	25,5	44,5	51	30	21	112,5	238	2,60 kg	QM/763
5	18	28,5	44,5	57	33,5	21	138	285,5	3,60 kg	QM/764
6	25	28,5	63,5	70	43	25,5	165	305	6,20 kg	QM/765
8	25	32	63,5	79,5	47,5	25,5	217,5	355,5	11,50 kg	QM/766
10	38	44,5	101,6	95,5	57	41	268,5	438	12,60 kg	QM/767
12	38	44,5	101,6	95,5	57	41	319	438	17,30 kg	QM/768
14	57	73	127	120,5	73	54	375	487,5	32,80 kg	QM/769

Universal piston rod eye – UF

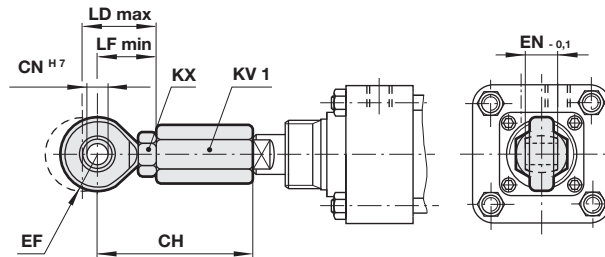
 Dimensions in mm
 Projection/First angle

Ø inch	CH	Ø CN H7	EF	EN -0,1	KV 1	KX	LD max.	LF min.	Z	Weight	Model
1 1/4	59	8	13	12	14	13	30	24	17°	0,07 kg	QM/1141
1 3/4	74	10	15	14	17	17	33	28	16°	0,13 kg	QM/1142
2	74	10	15	14	22	17	33	28	16°	0,17 kg	QM/1143
2 1/2	96,5	14	19	19	32	22	39	36	18°	0,43 kg	QM/1144
3	96,5	14	19	19	32	22	39	36	18°	0,43 kg	QM/1144
4	101	14	19	19	32	22	39	36	18°	0,44 kg	QM/1146

Universal rear eye – UR

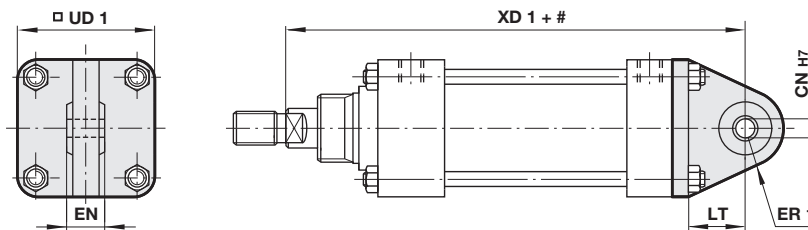

Stroke

Ø inch	Ø CN H7	EN	ER 1	LT	UD 1	XD 1	Z	Weight	Model
1 1/4	8	12	16	19	44,5	151,5	13°	0,18 kg	QM/1161
1 3/4	10	14	18	26	56,5	166,5	12°	0,30 kg	QM/1162
2	10	14	18	27	63	172	12°	0,43 kg	QM/1163
2 1/2	14	19	26	26	73	187,5	12°	0,60 kg	QM/1164
3	14	19	26	26	87,5	214,5	12°	0,75 kg	QM/1165
4	14	19	26	30	114	238	12°	2,40 kg	QM/1166
5	25	31	36	36	138	279	12°	2,70 kg	QM/950/33
6	30	37	43	39	176	290	12°	4,60 kg	QM/960/33
8	30	37	48	42	216	337	12°	7,30 kg	QM/980/33

Technical data - Reed switches - additional informations see data sheet N/en 4.3.005

Symbol	Voltage (V a.c.) (V d.c.)	Current maximum (mA)	Function	Operating temperature (°C)	LED	Protection class	Plug	Cable length (m)	Cable type	Weight (g)	Model	
	10 ... 240	10 ... 170	180	Closer	-25 ... +80	•	IP66	—	2,5 or 10	PVC 2 x 0,25	37	M/50/LSU/*V
	10 ... 240	10 ... 170	180	Closer	-25 ... +80	•	IP66	—	5	PUR 2 x 0,25	37	M/50/LSU/5U
	10 ... 240	10 ... 170	180	Closer	-25 ... +150	—	IP66	—	2	Silicon 2 x 0,25	37	TM/50/RAU/2S
	10 ... 240	10 ... 170	180	Changeover	-25 ... +80	—	IP66	—	5	PVC 3 x 0,25	37	M/50/RAC/5V
	10 ... 60	10 ... 60	180	Closer	-25 ... +80	•	IP66	M8 x 1	0,3	PVC 3 x 0,25	16	M/50/LSU/CP*1)

* Insert cable length; *1) Plug-in connector see page 11; Color code: BK = black, BN = brown, BU = blue

Drawings

M/50/LSU/*V, M/50/LSU/5U,
TM/50/RAU/2S
Cable length L = 2, 5 or 10 m

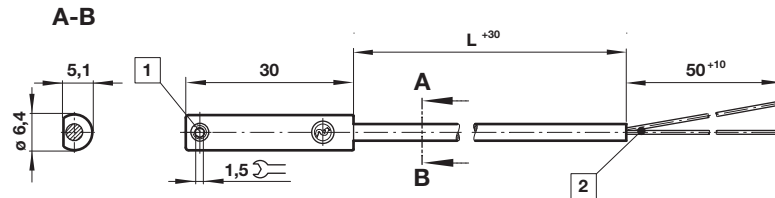

M/50/RAC/5V
Cable length L = 5 m

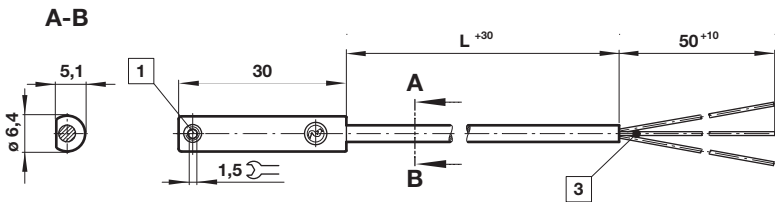

M/50/LSU/CP

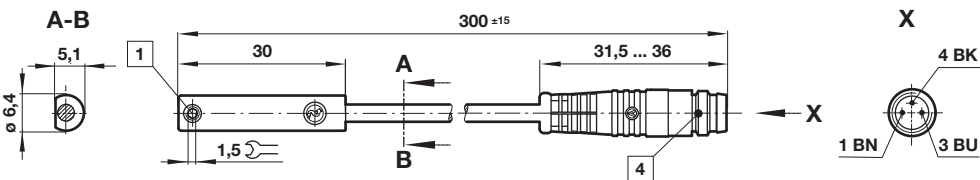

- 1 Fixing screw
- 2 + BN = brown; - BU = blue (output)
- 3 - BK = black; + BN = brown; - #BU = blue
- 4 Plug M8 x 1, color code: BK = black; BN = brown; BU = blue

Dimensions in mm
Projection/First angle

Switch mounting brackets - Brackets > 15 mm stroke

- 1 Magnetically operated switch
- 2 Switch mounting bracket

Switch mounting brackets - Brackets < 15 mm stroke

- 1 Magnetically operated switch
- 2 Switch mounting bracket

Ø	B	R max.	kg	Model
10	8	16	0,01	QM/33/010/22
12	8	18	0,01	QM/33/012/22
16	10	20	0,01	QM/33/016/22
20	10	22	0,01	QM/33/020/22
25	10	24	0,01	QM/33/025/22

Ø	S	T	kg	Model
10	27,5	19,5	0,01	QM/33/010/23
12	28,5	21,5	0,01	QM/33/016/23
16	29,5	23,5	0,01	QM/33/016/23
20	29,5	26	0,01	QM/33/020/23
25	31,5	28,5	0,01	QM/33/025/23

Technical data - Solid state - additional informations see data sheet N/en 4.3.007

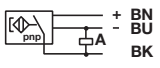
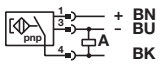
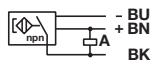
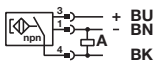
Symbol	Voltage (V d.c.)	Current maximum (mA)	Function	Operating temperature (°C)	LED	Protection class	Plug	Cable length (m)	Cable type	Weight (g)	Model
	10 ... 30	150	PNP	-40 ... +80	•	IP67	—	2, 5 or 10	PVC 3 x 0,12	37	M/50/EAP/*V
	10 ... 30	150	PNP	-40 ... +80	•	IP68	—	5	PUR 3 x 0,14	37	M/50/EAP/5U
	10 ... 30	150	PNP	-40 ... +80	•	IP67	M8 x 1	0,3	PVC 3 x 0,14	16	M/50/EAP/CP *1)
	10 ... 30	150	PNP	-40 ... +80	•	IP67	M12 x 1	0,3	PVC 3 x 0,14	16	M/50/EAP/CC *1)
	10 ... 30	150	NPN	-40 ... +80	•	IP67	—	2, 5 or 10	PVC 3 x 0,12	37	M/50/EAN/*V
	10 ... 30	150	Closer	-40 ... +80	•	IP67	M8 x 1	0,3	PVC 3 x 0,14	16	M/50/EAN/CP *1)

* Insert cable length; *1) Plug-in connector below; Color code: BK = black; BN = brown; BU = blue

Drawings

M/50/EAP/*V,
M/50/EAN/*V
Cable length L = 2, 5 or 10 m

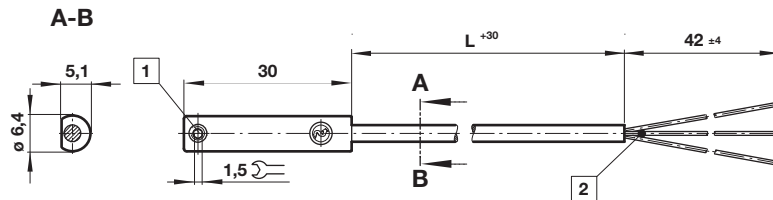

Dimensions in mm
Projection/First angle



M/50/EAP/CP,
M/50/EAN/CP

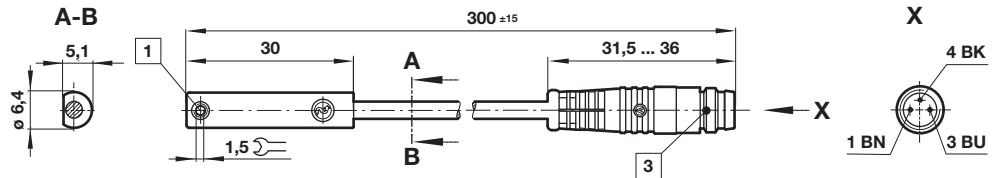

M/50/EAP/CC

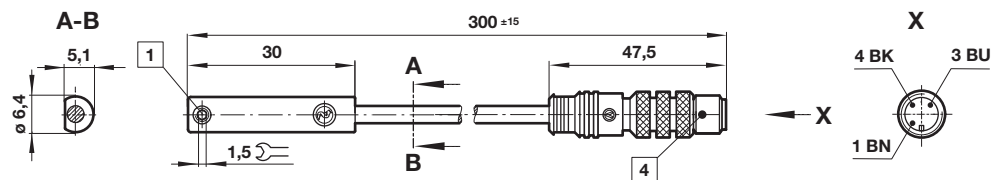

- 1 Fixing screw
- 2 Color code: BK = black; BN = brown; BU = blue
- 3 Plug M8 x 1
- 4 Plug M12 x 1

Accessories

Plug-in connector cable with nut



Outer cover	Cable length (m)	Weight (kg)	Connector	Connector
PVC 3 x 0,25	5 m	0,18	M8 x 1	M/P73001/5
PUR 3 x 0,25	5 m	0,18	M8 x 1	M/P73002/5
PUR 3 x 0,34	5 m	0,21	M12 x 1	M/P34594/5

Technical data - Reed switches - additional informations see data sheet N/en 4.3.021

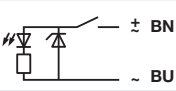
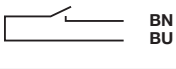
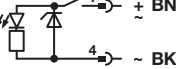
Symbol	Voltage (V a.c./V d.c.)	Current maximum (A)	Function	Temperature (°C)	LED	Protection class	Features	Cable length (m)	Cable type	Weight (g)	Model
	10 ... 240	1	Closer	-20 ... +80	•	IP66	—	2, 5 or 10	PVC 2 x 0,75	108 (2 m)	QM/32/*
	10 ... 240	1	Closer	-20 ... +80	•	IP66	—	2	PUR 2 x 0,75	108	QM/32/2/PU
	10 ... 240	2	Closer	-20 ... +150	—	IP66	High temperature	2, 5 or 10	Silicon 2 x 0,75	102 (2 m)	TQM/31/*
	10 ... 240	1	Closer	-20 ... +80	•	IP66	Plug M12 x 1	—	—	15	QM/32/P*1)

Technical data - Solid state - additional informations see data sheet N/en 4.3.025

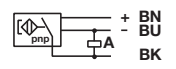
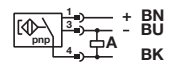
Symbol	Voltage (V d.c.)	Current maximum (mA)	Function	Temperature (°C)	LED	Protection class	Features	Cable length (m)	Cable type	Weight (g)	Model
	10 ... 30	200	PNP	-20 ... +80	•	IP66	—	2, 5 or 10	PVC 3 x 0,5	102 (2 m)	QM/132/*
	10 ... 30	200	PNP	-20 ... +80	•	IP66	—	5	PUR 3 x 0,34		QM/132/5/PU
	10 ... 30	200	PNP	-20 ... +80	•	IP66	Plug M12 x 1	—	—	15	QM/132/P*1)

* Insert cable length

*1) Plug-in connector see page below; Color code: BK = black, BN = brown, BU = blue

Drawings

TQM/31, QM/32, QM/132

QM/32/P, QM/132/P

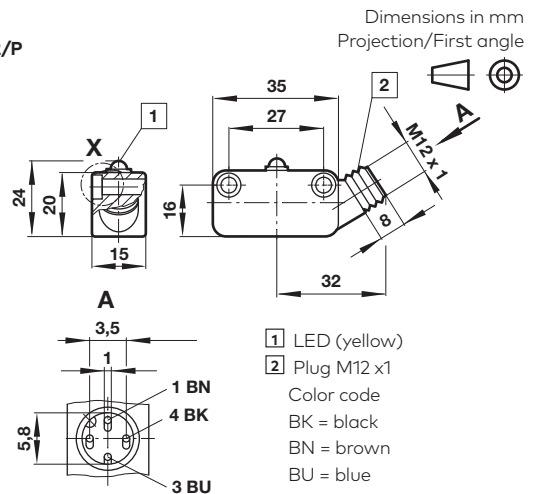
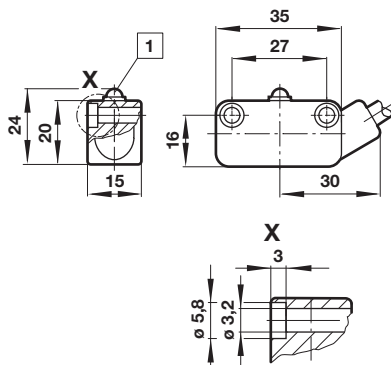
Accessories

Plug-in connector cable with nut



Outer cover	Cable length (m)	Weight (kg)	Connector	Connector
PVC 3 x 0,34	5 m	0,21	M12 x 1	M/P34692/5
PUR 3 x 0,34	5 m	0,21	M12 x 1	M/P34594/5

QM/31/000/22 – Switch mounting brackets

Switches: TQM/31, QM/32, QM/132

Dimensions in mm
Projection/First angle



Cyl. Ø	A	B	Weight (kg)	Model
32	4,5	38	0,026	QM/31/032/22
40	5,5	43	0,026	QM/31/032/22
50	4,5	48	0,026	QM/31/032/22
63	4,5	53	0,026	QM/31/032/22
80	1,5	61	0,028	QM/31/080/22
100	0,5	68	0,028	QM/31/080/22
125	-1	79	0,028	QM/31/080/22
160	0	91,5	0,023	QM/31/160/22
200	-4	106	0,023	QM/31/160/22
250	-3	138	0,041	QM/31/250/22
320	-21	154	0,080	QM/31/320/22

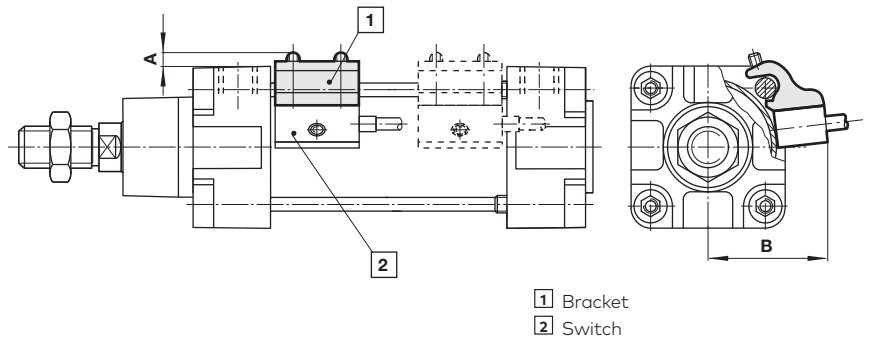

- 1 Bracket
- 2 Switch

Pneumatic proximity sensor - additional informations see data sheet N/en 4.3.061

Symbol	Operating pressure	Flow rate	Orifice size	Temperature	Optical indicator	Connections	Model
	2 ... 6 bar	40 l/min	2 mm	-15 ... +60°C	•	Pipes for 3 mm I/D tubing	QM/140

QM/140/010/22 – Bracket with holding strap

Pneumatic switch: QM/140

Cyl. Ø	A	B	Weight (kg)
32	31,5	18,5	0,020
40	30,5	18,5	0,020
50	31,5	18,5	0,020
63	29,5	18,5	0,020
80	30,5	18,5	0,020
100	30	18,5	0,020

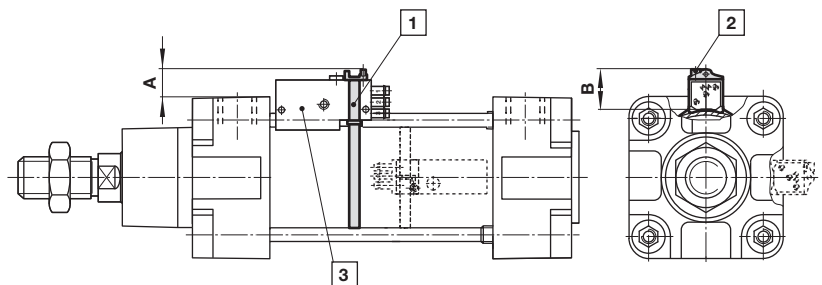

- 1 Holding strap
- 2 Optical indicator
- 3 Pneumatic switch

Warning

These products are intended for use in industrial compressed air systems only. Do not use these products where pressures and temperatures can exceed those listed under »**Technical features/ data**«.

Before using these products with fluids other than those specified, for non-industrial applications, life-support systems or other applications not within published specifications, consult IMI Precision Engineering.

Through misuse, age, or malfunction, components used in fluid power systems can fail in various modes.

The system designer is warned to consider the failure modes of all component parts used in fluid power systems and to provide adequate safeguards to prevent personal injury or damage to equipment in the event of such failure.

System designers must provide a warning to end users in the system instructional manual if protection against a failure mode cannot be adequately provided.

System designers and end users are cautioned to review specific warnings found in instruction sheets packed and shipped with these products.