

M/31000, M/32000, Air bellows Single acting

- Ø 6 ... 26 inch (152 ... 660 mm)
- Almost frictionless operation
- No maintenance or lubrication
- High isolation level for vibration applications
- Very easy to install – no alignment problems
- Typical applications; actuator, air spring, or vibration isolation



Technical features

Medium:

Compressed air lubricated or unlubricated, Nitrogen, water (with glycol)

Operation:

Single acting

Operating pressure:

5,5 bar (79 psi) recommended dynamic pressure
8 bar (116 psi) maximum

Nominal diameters:

6, 8, 10, 12, 14 1/2, 16, 21, 26 inches

Strokes:

From 55 ... 430 mm max., depending on diameters and number of convolutions

Operating temperature:

for M/31000 (Standard)
-30° ... +50°C (-22° ... +122°F)
-40° ... +70°C* (-40° ... +158°F)*
IR for TM/31000
-20° ... +70°C (-4° ... 158°F)
-25° ... +90°C* (-13° ... 194°F)*
ECO for EM/31000
+50° ... +115°C (+122° ... 239°F)
-20° ... +130°C* (-4° ... +266°F)*
* The number represent the maximum permissible operating temperature. It is sutibel to operated with restriction at this temperature, the air bellow may have a reduced life time!

Materials:

End plates: steel, chromplated
Studs: steel, zinc plated
Central ring: aluminium or steel, chromplated, partly moulded in Bellow: M/31000, M/32000: NR/BR, SBR compound rubber
TM/31000, TM/32000: IR
EM/31000, EM/32000: ECO

Technical data

Model	M/31061	M/31062	M/31081	M/31082	M/31101	M/31102	M/31103	M/31121	M/31122
Cylinder Ø [inch]	6"	6"	8"	8"	10"	10"	10"	12"	12"
Port size	G1/2	G1/2	G1/2	G1/2	G1/2	G1/2	G1/2	G1/2	G1/2
Nominal Ø (inch) x convolutions	6" x 1	6" x 2	8" x 1	8" x 2	10" x 1	10" x 2	10" x 3	12" x 1	12" x 2
Stroke [mm]	55	115	75	175	100	225	330	100	225
Installation height min [mm]	50	75	50	75	50	75	100	50	75
Recomended max working height [mm]	95	170	115	220	135	245	350	135	245
Installation height max [mm]	105	190	130	250	150	300	430	150	300
Retracting force to rech min height [N]	140	220	220	350	150	150	250	200	250
Force at 6 bar [N] depending from the stroke	See graph on page 5 & 6								
Model	M/31123	M/31141	M/31142	M/31143	M/31162	M/31163	M/32212	M/32262	
Cylinder Ø [inch]	12"	14 1/2"	14 1/2"	14 1/2"	16"	16"	21"	26"	
Port size	G1/2	G1/2	G1/2	G1/2	G1/2	G1/2	-	-	
Nominal Ø (inch) x convolutions	12 x 3	14 1/2" x 1	14 1/2" x 2	14 1/2" x 3	16 x 2	16 x 3	21" x 2	26" x 2	
Stroke [mm]	330	100	265	380	315	430	251	400	
Installation height min [mm]	100	50	75	100	75	120	84	100	
Recomended max working height [mm]	350	135	290	420	350	475	284	425	
Installation height max [mm]	430	150	340	480	390	550	335	500	
Retracting force to rech min height [N]	250	200	280	330	250	100	311	400	
Force at 6 bar [N] depending from the stroke	See graph on page 5 & 6								

Alternative air bellows

Symbol	Model	Material	Description	Dimension see page
	M/31000	Standard	Ø 6 ... 16 inches (125 ... 406 mm)	3
	M/32000	Standard	Ø21 ... 26 inches (533 ... 660 mm)	3 & 4
	TM/31000	IR	Ø 6 ... 16 inches (125 ... 406 mm)	3
	TM/32000	IR	Ø21 inches (533 mm)	3
	EM/31000	ECO	Ø 6 ... 16 inches (125 ... 406 mm)	3
	EM/32000	ECO	Ø21 inches (533 mm)	3

Options selector

★M/3★ ★ ★ ★ ★

Air bellow materials	Substitute	Number of convolutions	Substitute
NR/BR, SBR compound rubber	None	1	1
High temperature (IR)	T	2	2
Extreme temperature (ECO)	E	3	3
Variants	Substitute	Nominal diameters (inches)	Substitute
Standard with bead ring and plate	1	6	06
Only with bead ring (21° & 26°)	2	8	08
		10	10
		12	12
		14 1/2	14
		16	16
		21	21
		26	26

Note: Please fill in only the numbers of digits required, e.g. M/31082



Important instructions:

Thrust:

The thrust depends on the height of the bellow. When height increases - the thrust decreases.

- Before installing the air bellow, check it carefully for any damage it may have suffered from transport or improper storage.

- Do not inflate the air bellow until it has been secured properly.

Clearance:

There must be enough clearance around the air bellow.

- The full surface of the metal parts is to be used to bear the forces.

- Air bellows must be equipped with lateral guides.

- Deflate the air bellows fully before removing.

- Ensure that the bellows is not constantly in contact with hydraulic oil, lubricants, solvents, metal cuttings and welding sparks.

- Should the air bellow be subjected to special media in an application, ask Norgren for further information, specifying the medium, temperature and concentration

Stops:

To avoid damage when the bellow is compressed or extended mechanical stops at both end positions have to be used.

Basic dimensions M/31061 ... M/31163

Dimensions in mm
Projection/First angle

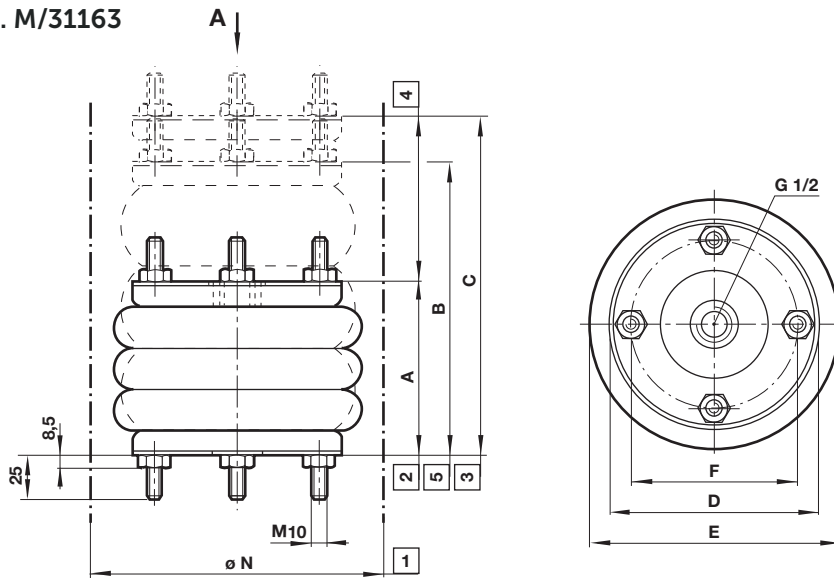

- 1 Installation diameter min.
- 2 Installation height min.
- 3 Installation height max.
- 4 Stroke
- 5 Recommended max. working height

Table 1

Nominal Ø (inch) x convolutions	Stroke (mm)	Installation height [A] min. (mm)	Recommended working height [B] max. (mm)	Installation height [C] max. (mm)	Max. torque for mounting studs (Nm)	Natural frequency [fn] at 4 bar (Hz)	Siffness at 4 bar (N/mm)	Recommended vibration height [mm]	Ø E	Ø D	Ø F	Ø N	Weight (kg)	Model
6" x 1	55	50	95	105	25	3,63	250	85	175	154	127	190	2,2	M/31061
6" x 2	115	75	170	190	25	2,23	83	155	175	154	127	190	2,2	M/31062
8" x 1	75	50	115	130	25	2,72	250	100	230	184	155,5	245	3,0	M/31081
8" x 2	175	75	220	250	25	1,86	105	200	230	184	155,5	245	3,7	M/31082
10" x 1	100	50	135	150	25	2,6	257	120	270	210	181	300	4,1	M/31101
10" x 2	225	75	245	300	25	1,8	123	220	270	210	181	300	4,7	M/31102
10" x 3	330	100	350	430	25	-	-	-	270	210	181	300	5,2	M/31103
12" x 1	100	50	135	150	25	2,5	372	120	330	260	232	350	5,4	M/31121
12" x 2	225	75	245	300	25	1,8	200	220	330	260	232	350	6,2	M/31122
12" x 3	330	100	350	430	25	-	-	-	330	260	232	350	6,9	M/31123
14 1/2" x 1	100	50	135	150	25	2,4	558	130	400	310	282,5	425	7,1	M/31141
14 1/2" x 2	265	75	290	340	25	1,6	252	250	400	310	282,5	425	8,3	M/31142
14 1/2" x 3	380	100	420	480	25	-	-	-	400	310	282,5	425	9,6	M/31143
16" x 2	315	75	350	390	25	2,2	485	300	435	310	282,5	460	7,6	M/31162
16" x 3	430	120	475	550	25	-	-	-	430	310	282,5	455	10,4	M/31163

M/32212

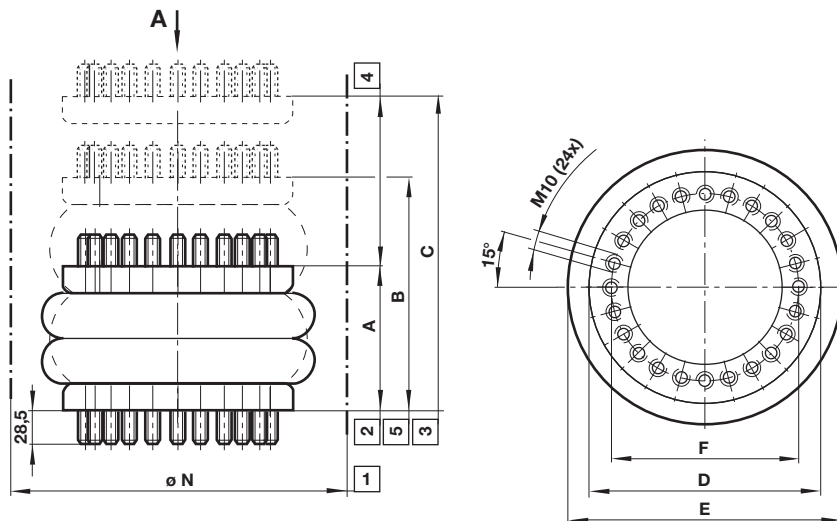

- 1 Installation diameter min.
- 2 Installation height min.
- 3 Installation height max.
- 4 Stroke
- 5 Recommended max. working height

Table 1.1

Nominal Ø (inch) x convolutions	Stroke (mm)	Installation height [A] min. (mm)	Recommended working height [B] max. (mm)	Installation height [C] max. (mm)	Max. torque for mounting studs (Nm)	Natural frequency [fn] at 4 bar (Hz)	Siffness at 4 bar (N/mm)	Recommended vibration height [mm]	Ø E	Ø D	Ø F	Ø N	Weight (kg)	Model
21" x 2	251	84	284	335	40	1,6	682	240	577	517	482	620	12,0	M/32212

Caution: End plates aren't included as standard in scope of supply of air bellows. Consult our technical service for details of end plates.

M/32262

Dimensions in mm
Projection/First angle

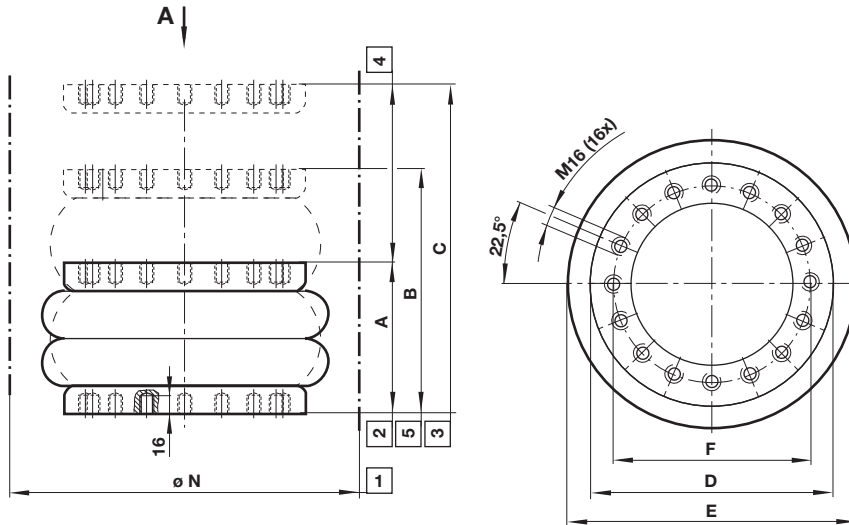

- 1 Installation diameter min.
- 2 Installation height min.
- 3 Installation height max.
- 4 Stroke
- 5 Recommended max. working height

Table 1.2

Nominal Ø (inch) x convolutions	Stroke (mm)	Installation height [A] min. (mm)	Recommended working height [B] max. (mm)	Installation height [C] max. (mm)	Max. torque for mounting studs (Nm)	Natural frequency [fn] at 4 bar (Hz)	Siffness at 4 bar (N/mm)	Recommended vibration height [mm]	Ø E	Ø D	Ø F	Ø N	Weight (kg)	Model
26" x 2	400	100	425	500	100	-	-	-	710	750	495	750	33,2	M/32262

Caution: End plates aren't included as standard in scope of supply of air bellows. Consult our technical service for details of end plates.

Operation angle

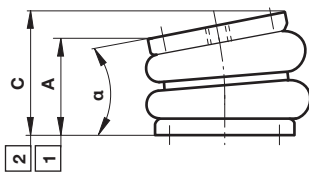

- 1 Installation height min
- 2 Installation height max

Out of alignment

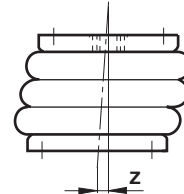

Table 2

Nominal Ø (inch) x convolutions	Operating angel [] max. (°)	Out of alignment [Z] max. (mm)	Installation height [A] min. (mm)	Installation height [C] max. (mm)	Models
6" x 1	10	10	50	105	M/31061
6" x 2	10	10	75	190	M/31062
8" x 1	10	10	50	130	M/31081
8" x 2	10°	10	75	250	M/31082
10" x 1	10 ... 20	10	50	150	M/31101
10" x 2	15 ... 25	20	75	300	M/31102
10" x 3	15 ... 30	30	100	430	M/31103
12" x 1	10 ... 20	10	50	150	M/31121
12" x 2	15 ... 25	20	75	300	M/31122
12" x 3	15 ... 30	30	100	430	M/31123
14 1/2" x 1	10 ... 20	10	50	150	M/31141
14 1/2" x 2	15 ... 25	20	75	340	M/31142
14 1/2" x 3	15 ... 30	30	100	480	M/31143
16" x 2	15 ... 25	20	75	390	M/31162
16" x 3	15 ... 30	30	120	550	M/31163
21" x 2	15 ... 25	20	84	335	M/32212
26" x 2	15 ... 25	20	100	500	M/32262

Operation angle

Tilt angles from 10 ... 30° are possible, depending on the air bellow design. Ensure application is within minimum and maximum installation heights.

Thrust (at 2, 4, 6, 8 bar), volume (at 6 bar)

M/31061

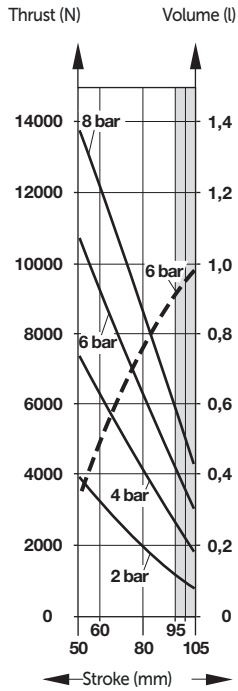

M/31062

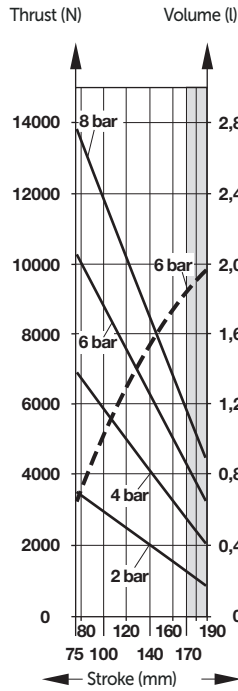

M/31081

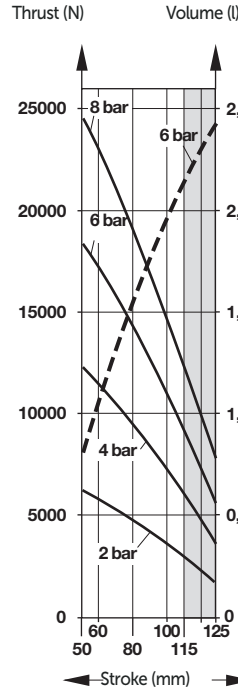

M/31082

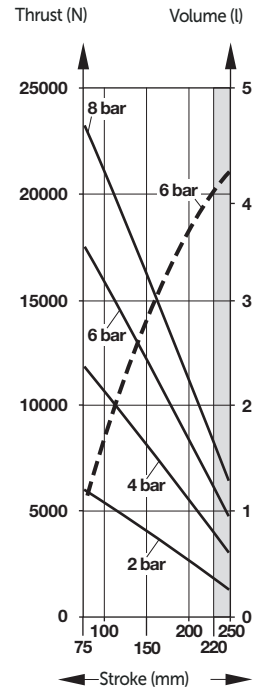

M/31101

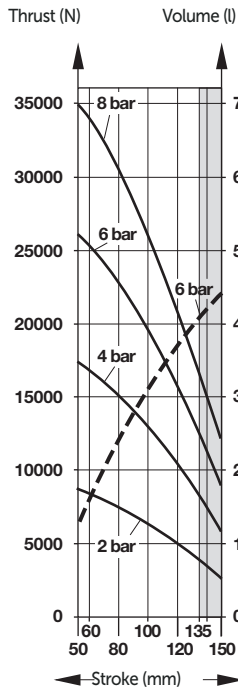

M/31102

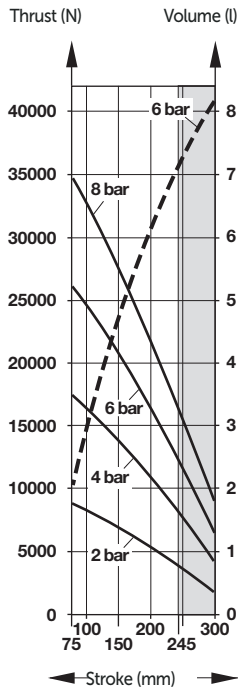

M/31103

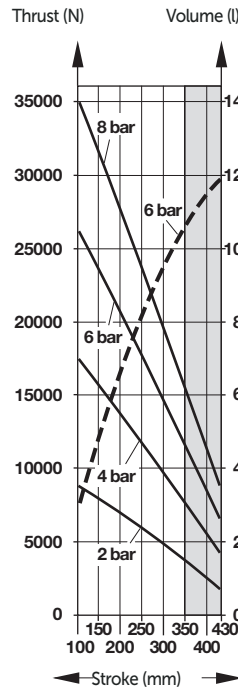

M/31121

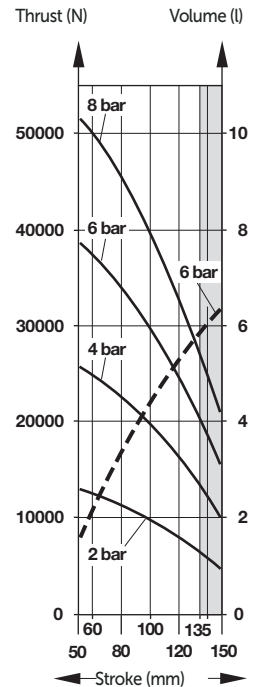

— Thrust (N) - - Volume (l)

Caution!

Ensure that all applications are within the max. installation height. For applications in the grey area please contact Norgren technical service.

Thrust (at 2, 4, 6, 8 bar), volume (at 6 bar)

M/31122

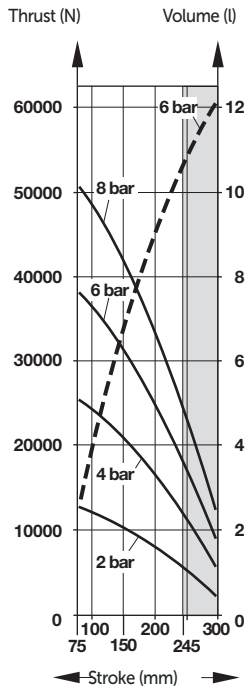

M/31123

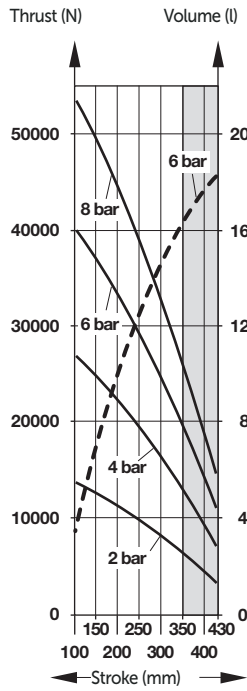

M/31141

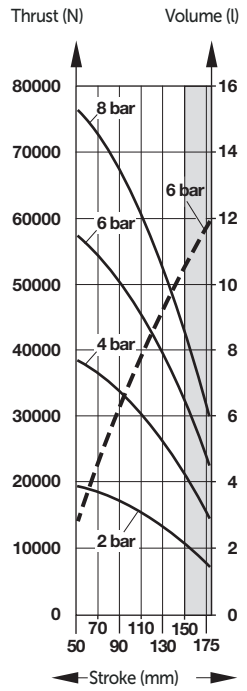

M/31142

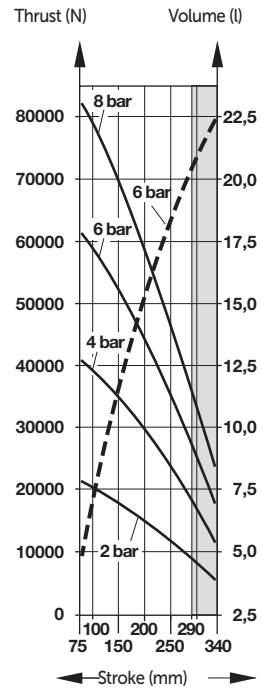

M/31143

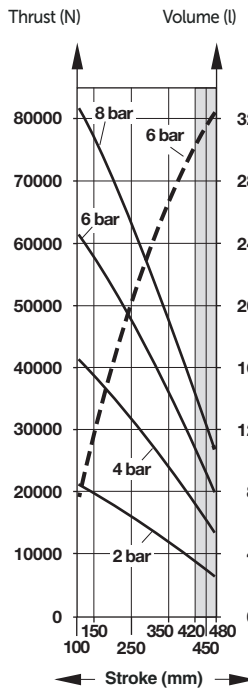

M/31162

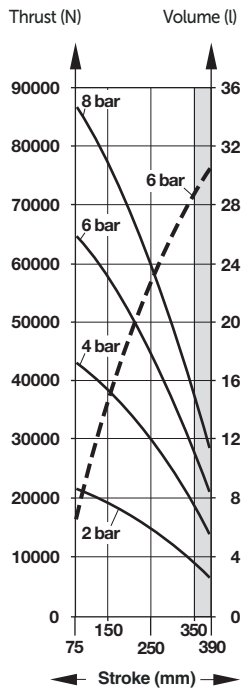

M/31163

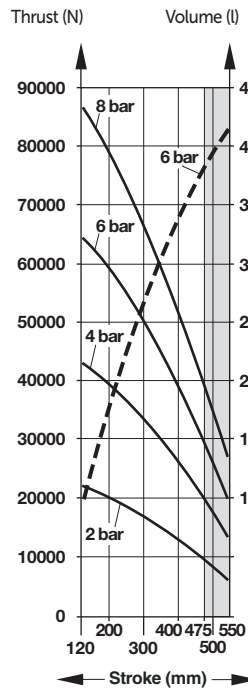

M/32212

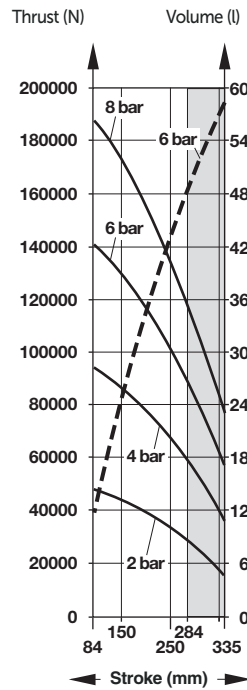

M/32262

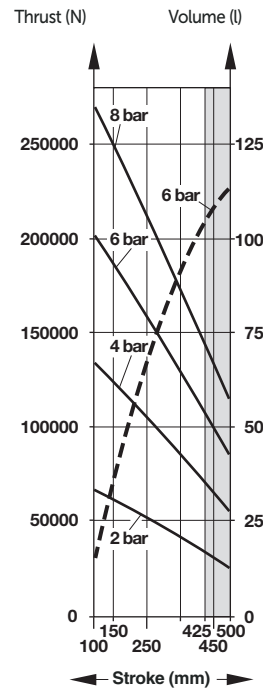

— Thrust (N) - - Volume (l)

Caution!

Ensure that all applications are within the max. installation height. For applications in the grey area please contact Norgren technical service.

Application example - Air bellow as an actuator

A 1000 kg conveyor carrying a 550 kg pallet needs to be lifted by 90 mm (stroke) in order to transfer the pallet to another level. Four (4) air bellows should be used. The available operating pressure is 5 bar. The operating temperature is 45°C. There is a 270 mm square space to house each air bellow. Compression and extension stops are provided. The air bellows have to be mounted in a space which is 85 mm apart. During the lifting operation the conveyor may tilt in the second half of the stroke by a max. of 9°.

Step 1: Fill in and complete the datasheet

a) Total weight to be lifted:	F =	$(1000 \text{ kg} + 550 \text{ kg}) \times 10 \text{ m/s}^2 = 15500 \text{ N}$
b) Number of air bellows:	n =	4
c) Thrust per air bellow:	f =	$\frac{15500 \text{ N}}{4} = 3875 \text{ N}$
d) Operating pressure:	P =	5 bar
e) Required stroke:	S =	90 mm
f) Vertical space:	Xv =	85 mm
g) Horizontal space:	Xh =	270 mm
h) Operating temperature:	T =	45°C
i) Operation angle:	a =	9°
j) Out of alignment:	A =	0 mm
k) Chemical resistance:		normal environment

Step 2:

From table 1 air bellows have to be selected, that have a stroke of 90 mm and clearance around the air bellows smaller than Xh = 270 mm. We select: M/31062 and M/31082

Step 3:

Calculate the total height at which the air bellow should be used,

Vertical space	Xv 85 mm
Stroke	S 90 mm
Total height	175 mm

By referring to the total height of 175 mm and the vertical space of 85 mm

M/31062 Installation height (A) min = 75 mm
Installation height (C) max = 190 mm

and

M/31082 Installation height (A) min = 75 mm
Installation height (C) max = 250 mm

can be used from table 1

Step 4:

Check the thrust at 5 bar at a height of 175 mm. From the charts in the datasheet 5 we can see that:

M/31062

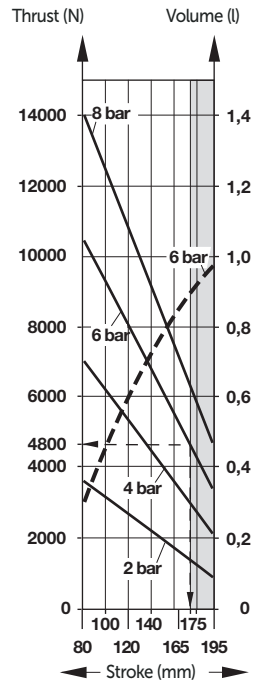

M/31062 will provide 4800 N at 6 bar. To get the figure for 5 bar, we have to calculate:

$$\frac{4800 \text{ N} \times 5}{6} = 4000 \text{ N at 5 bar}$$

M/31082

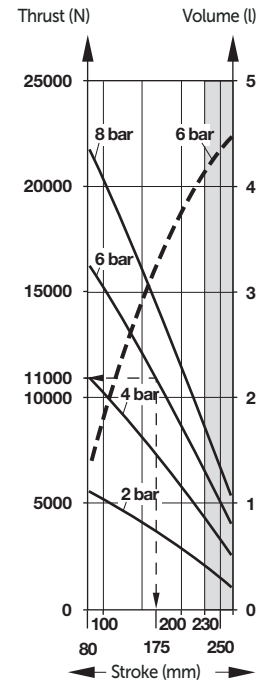

M/31082 will provide 11500 N at 6 bar. To get the figure for 5 bar, we have to calculate:

$$\frac{11500 \text{ N} \times 5}{6} = 9166 \text{ N at 5 bar}$$

Result:

Both air bellows can provide the required thrust of 3875 N. But the M/31062 is still working on the critical zone and force can drop done via pressure issue. Please select the bigger one M/31082.

Step 5:

Check the operation angel and the out of alignment when the selected air bellow can tilt, see table 2.

- i) max. operation angle 10° is higher as existing operating angel 9°.
- j) max. out of alignment is 10 mm is higher as existing alignment 0 mm.

Result:

M/31082 can be used.

Step 6:

- Check all remaining parameters
- h) At 45°C Standard rubber material -30 ... + 50°C
- k) No special chemical resistance is required

Result:

M/31082 is the chosen air bellow, because it meets all requirements.

Application example - Air bellow as a vibration isolator

A hydraulic power unit with an excitation frequency (f_e) between 1200 and 3000 cycles/min. (= 20 to 50 Hz) must be vibration isolated. The total weight of the power unit is 3800 kg. The supporting area under the unit is 1,2 m x 0,8 m. The operating temperature is 50°C. The space for the installation is 240 mm high. Four air bellows will be used. The max. operating pressure is 4 bar. A minimum of 97% vibration isolation has to be reached..

Step 1: Fill in and complete the datasheet

a) Total weight to be isolated:	F = 3800 kg x 10 m/s ² = 38000 N
b) Number of air bellows:	n = 4
c) Thrust per air bellow:	$f = \frac{38000 \text{ N}}{4} = 9500 \text{ N}$
d) Operating pressure:	P = 4 bar
f) Vertical space:	Xv = 240 mm
g) Horizontal space:	Xh = 400 mm (0,8 m / 2)
h) Operating temperature:	T = 50°C
k) Chemical resistance:	normal environment
m) Minimum isolation rate:	l = 97%
p) Excitation frequency	$f_e = \text{min. } 20 \text{ Hz, max. } 50 \text{ Hz}$

Two types of air bellows are chosen. Each one has to work with a vibration height lower than 240 mm and fit in a horizontal space smaller than 400 mm. From table 1 we select:

1. M/31102 - Vibration height = 220 mm - Clearance around the air bellow = 300 mm - Airspring natural frequency " f_n " at 4 bar = 1,8 Hz - Stiffness at 4 bar = 123 N/mm
2. M/31122 - Vibration height = 220 mm - Clearance around the air bellow = 350 mm - Airspring natural frequency " f_n " at 4 bar = 1,8 Hz - Stiffness at 4 bar 200 N/mm

Step 2:

Take the air bellow with the lowest airspring natural frequency $f_n = 1,8 \text{ Hz}$. Do to the fact that both air bellows constater the same natural frequency. Please use the lowest stiffness at 123 N/mm in order to get the highest isolation rate referring to $f_e \text{ min.} = 20 \text{ Hz}$. Air bellow M/31102 is chosen.

Step 3:

Calculate the isolation rate (l) of the M/31102 by using the formula:

Formula:

$$l = 1 - \frac{1}{\left(\frac{f_e}{f_n}\right)^2 - 1}$$

Example:

$$l = 1 - \frac{1}{\left(\frac{20}{1,8}\right)^2 - 1}$$

$$l = 99,1\%$$

$$= 1 - \frac{1}{122,4} = 0,991$$

Step 4:

Check the thrust at 4 bar at a height of 220 mm. From the charts in the datasheet page 5 we can see that.

M/31102

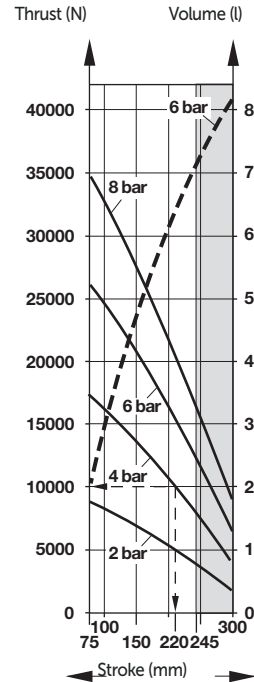

M/31102 will provide 10000 N as a vibration height of 220 mm at 4 bar

Step 5:

Check all remaining parameters

- h) At 50°C Standard rubber material (-30 ... +50°C) can be used.
- g) No special chemical resistance is required

Result:

4 x M/31102 air bellows are chosen. They will provide 99,1% vibration isolation and lift the 3800 kg weight at 4 bar.

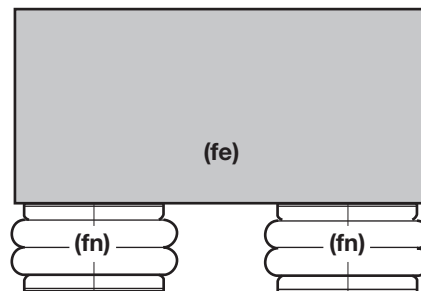

f_e = Excitation frequency of load
 f_n = Airspring natural frequency

Warning

These products are intended for use in industrial compressed air systems only. Do not use these products where pressures and temperatures can exceed those listed under »**Technical features/ data**«.

Before using these products with fluids other than those specified, for non-industrial applications, life-support systems or other applications not within published specifications, consult Norgren.

Through misuse, age, or malfunction, components used in fluid power systems can fail in various modes.

The system designer is warned to consider the failure modes of all component parts used in fluid power systems and to provide adequate safeguards to prevent personal injury or damage to equipment in the event of such failure.

System designers must provide a warning to end users in the system instructional manual if protection against a failure mode cannot be adequately provided.

System designers and end users are cautioned to review specific warnings found in instruction sheets packed and shipped with these products.