

Slim but robust construction make these units ideal for moving relatively heavy loads within a confined space

Light weight

Magnetic switching for positional feedback

Excellent service life

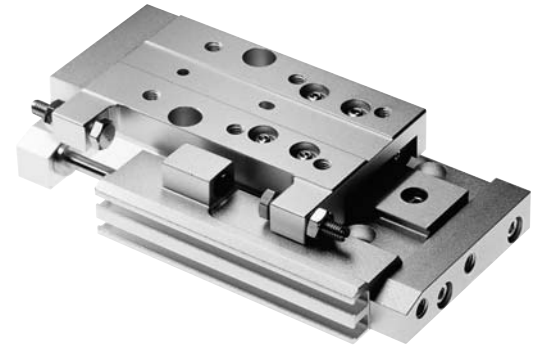

Technical data

Medium:
Compressed air, filtered, lubricated or non-lubricated

Operation:
Double acting with linear guide

Operating pressure:
2 to 7 bar

Operating temperature:
+5°C to +60°C

Consult our Technical Service for use below +2°C

Cylinder diameters:
8, 10, 15, 20 mm

Strokes:
30, 45, 60 mm (Ø 8 & 10 mm)
30, 45, 60, 80, 100 mm (Ø 15 & 20 mm)

Speed:
300 mm/s maximum

Materials

Slide table, body and end plates: aluminium alloy

Piston rod: stainless steel

Linear guide: stainless steel

Stroke adjustment bolts and nuts: nickel plated carbon steel

Elastomers: synthetic rubber

Ordering information

See page 2

Alternative cylinders

See page 2

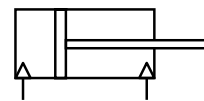

Non-magnetic

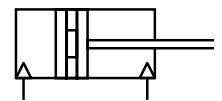

Magnetic

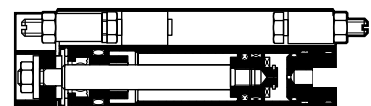



Alternative cylinders

Symbol	Model Non-magnetic	Symbol	Model Magnetic	Description	Page
	M/261200/IR/I		M/261200/MR/I	Standard location of stroke adjusters and switch rail	7 + 9
	M/261200/IR/S		M/261200/MR/S	Symmetrical location of stroke adjusters and switch rail	8 + 10

Options selector

M/2612**/MR/****

Piston diameter (mm)	Substitute	Standard stroke length (mm)	Location of switch rail and stroke adjusters	Substitute
8	08	30, 45 & 60 mm (Ø 8 & 10 mm)	Standard	I
10	10	30, 45, 60, 80 & 100 mm (Ø 15 & 20 mm)	Symmetric	S
15	15			
20	20			
Piston type	Substitute			
Magnetic	M			
Non-magnetic	I			

Standard strokes

Ø (mm)	30	45	60	80	100
8	●	●	●		
10	●	●	●		
15	●	●	●	●	●
20	●	●	●	●	●

Ordering examples

To order a Ø 15 mm low profile linear slide table with magnetic piston, in and outstroke adjustment with rubber stops (standard location of stroke adjusters and switch rail) a 45 mm stroke length, specify part number

quote: **M/261215/MR/I/45**





Switches

To order a two wire solid state switch with LED indication, 1 m cable and 90° cable connection, specify part number

quote: **M/419/EAU/11**



Switches with LED indication

Reed In-line cable	Reed 90° cable	Solid state In-line cable	Solid state 90° cable
			
M/369/LSU/1	M/370/LSU/1	M/418/EAU/1	M/419/EAU/1
M/369/LSU/3	M/370/LSU/3	M/418/EAU/3	M/419/EAU/3
		M/420/EAN/1	M/421/EAN/1
		M/420/EAN/3	M/421/EAN/3

Model	Reed	Solid state	Voltage V d.c.	Current max.	Temperature °C	Output	Protection rating	Cable wire material	Cable type	Cable length	Page
M/369/LSU/1			12 ... 24	24 mA	+5 ... +60	–	IP 67	PVC 2 x 0,18	In-line	1 m	N/UK 4.3.091
M/369/LSU/3			12 ... 24	24 mA	+5 ... +60	–	IP 67	PVC 2 x 0,18	In-line	3 m	N/UK 4.3.091
M/370/LSU/1			12 ... 24	24 mA	+5 ... +60	–	IP 67	PVC 2 x 0,18	90°	1 m	N/UK 4.3.091
M/370/LSU/3			12 ... 24	24 mA	+5 ... +60	–	IP 67	PVC 2 x 0,18	90°	3 m	N/UK 4.3.091
		M/418/EAU/1	12 ... 24	40 mA	+5 ... +60	PNP	IP 67	PVC 2 x 0,15	In-line	1 m	N/UK 4.3.093
		M/418/EAU/3	12 ... 24	40 mA	+5 ... +60	PNP	IP 67	PVC 2 x 0,15	In-line	3 m	N/UK 4.3.093
		M/419/EAU/1	12 ... 24	40 mA	+5 ... +60	PNP	IP 67	PVC 2 x 0,15	90°	1 m	N/UK 4.3.093
		M/419/EAU/3	12 ... 24	40 mA	+5 ... +60	PNP	IP 67	PVC 2 x 0,15	90°	3 m	N/UK 4.3.093
		M/420/EAN/1	5 ... 24	50 mA	+5 ... +60	NPN	IP 67	PVC 3 x 0,18	In-line	1 m	N/UK 4.3.093
		M/420/EAN/3	5 ... 24	50 mA	+5 ... +60	NPN	IP 67	PVC 3 x 0,18	In-line	3 m	N/UK 4.3.093
		M/421/EAN/1	5 ... 24	50 mA	+5 ... +60	NPN	IP 67	PVC 3 x 0,18	90°	1 m	N/UK 4.3.093
		M/421/EAN/3	5 ... 24	50 mA	+5 ... +60	NPN	IP 67	PVC 3 x 0,18	90°	3 m	N/UK 4.3.093



Theoretical forces

Ø mm	Theoretical forces (N) at 6 bar	
	Outstroke	Instroke
8	30	26
10	47	40
15	106	76
20	188	141

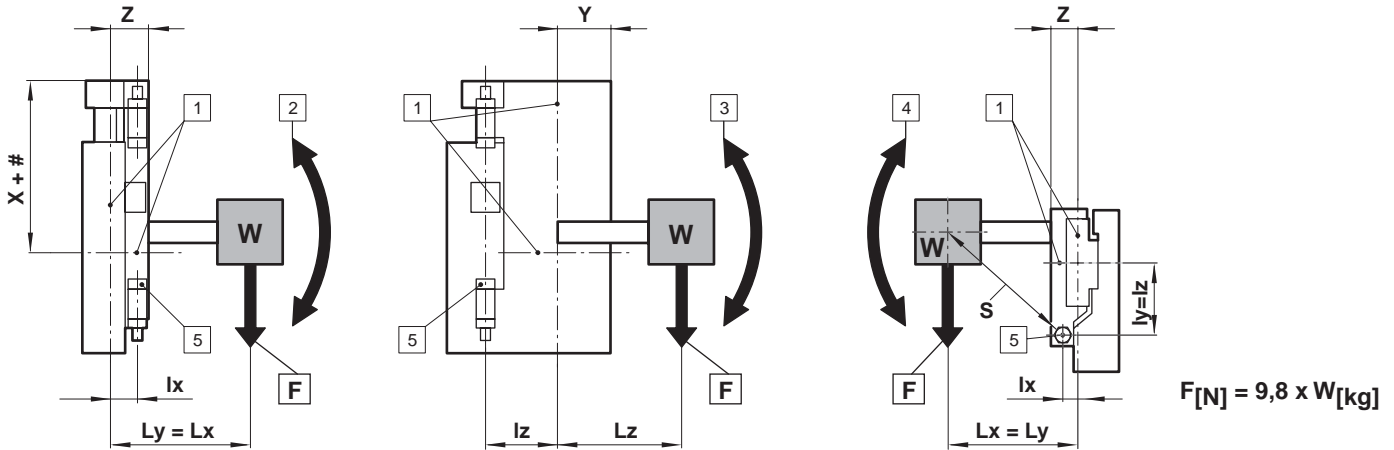

W(kg): mass of a loaded work

F(N): gravity acting on a loaded work

Lx, Ly, Lz (m): distance between the centre line of the guide and centre of gravity of the loaded work.

ix, iz, Y and Z (m): distance between guide centre line and the surface of the table or the adjuster bolt

S(m): distance between centre line of the guide and the adjust bolt

#	Stroke
1	Guide centre line
2	Moment My
3	Moment Mz
4	Moment Mx
5	Adjustment bolt

Theoretical moments and maximum load

Ø mm	Theoretical moments (Nm)			Maximum load (kg)
	Mx	My	Mz	
8	1,3	0,45	0,45	1,5
10	2,1	0,79	0,88	2,0
15	4,5	1,6	1,7	4,0
20	13	3,6	3,4	8,0

To calculate a theoretical moment use the following formula -

Gravity acting on load (9,8) x mass of load (kg) x distance between centre line of linear slide table and load's centre of gravity (mm).

Calculated values should not exceed those in the table above.

Position of the guide and adjuster bolt

Ø mm	Guide centre line positions (m)			Distance*(m)	
	X	Y	Z	ix	iy=iz
8	0,027	0,017	0,010	0,007	0,022
10	0,034	0,020	0,011	0,007	0,027
15	0,039	0,025	0,015	0,010	0,033
20	0,051	0,037	0,021	0,015	0,048

* Distance between the centre line of the guide and that of adjust bolt



Maximum inertia mass

When a linear slide table stops at the end of its stroke a force is generated due to the inertia of the load. The value of this force depends on various conditions. The graphs below consider the speed of movement, mass of the load and the distance between the load's centre

of gravity and the stroke adjustment bolt of the linear slide table (dimension 'S' in the drawing on page 04 that details rolling moment 'Mx'). These graphs can be used as a guide to the allowable values of the load.

Ø 8 mm

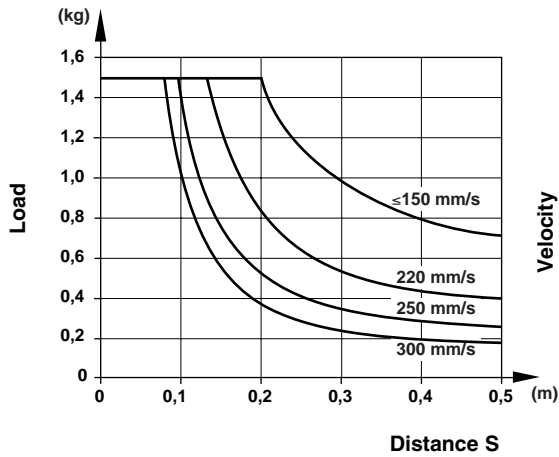

Ø 10 mm

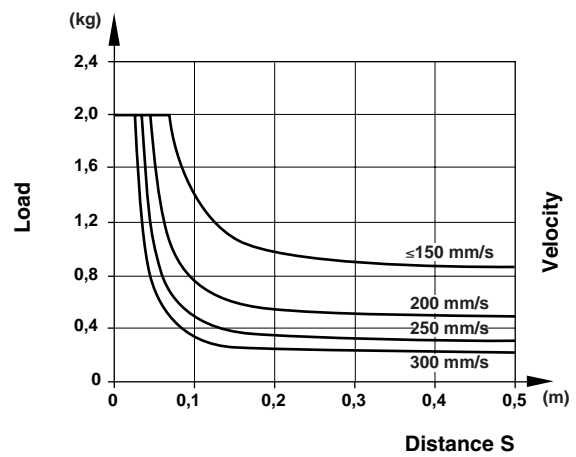

Ø 15 mm

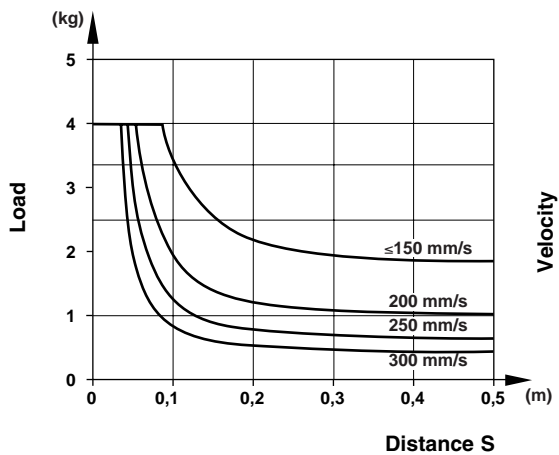

Ø 20 mm

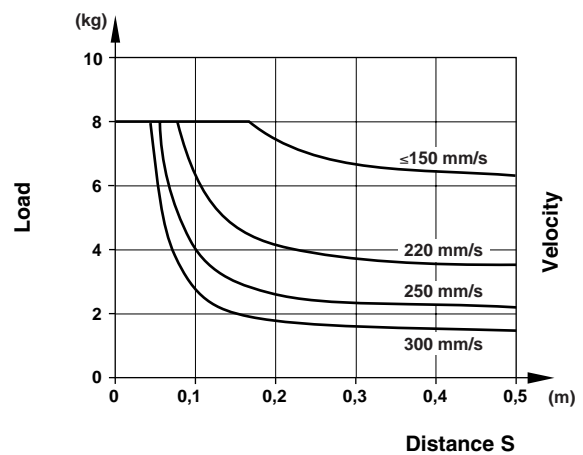
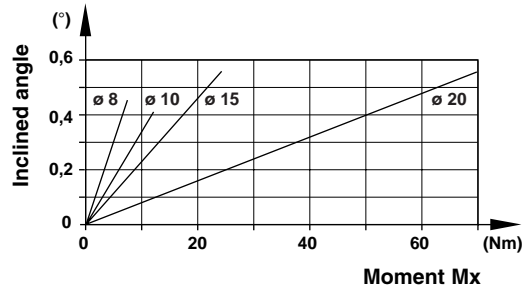
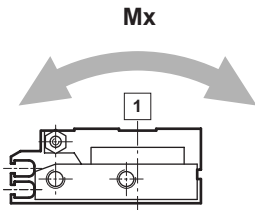

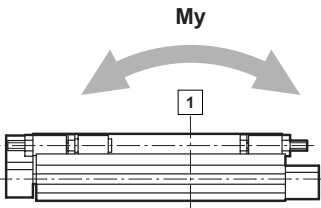

Table deflection Moment Mx



1 Guide centre line

Moment My



1 Guide centre line

Ø 8 mm

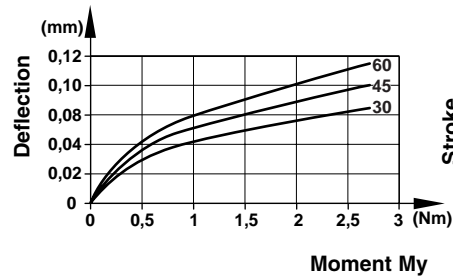

Ø 10 mm

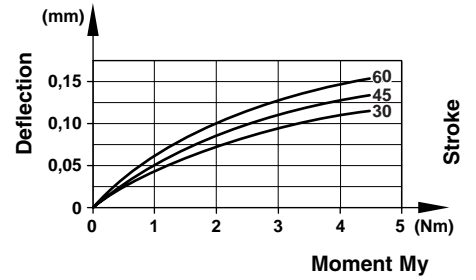

Ø 15 mm

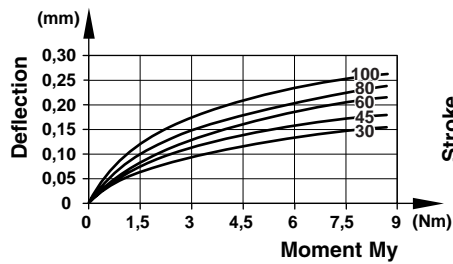

Ø 20 mm

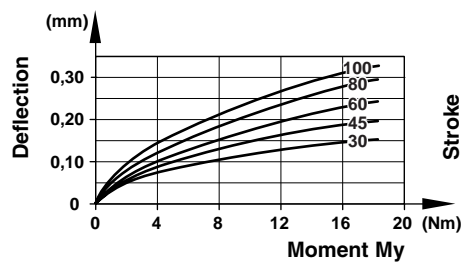

Moment Mz

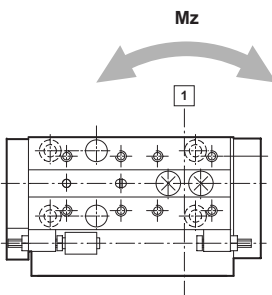

1 Guide centre line

Ø 8 mm

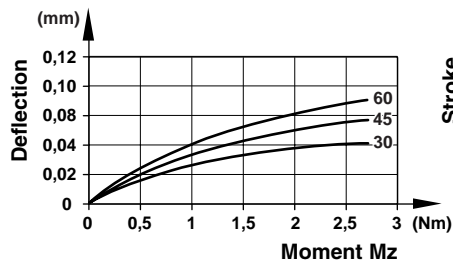

Ø 10 mm

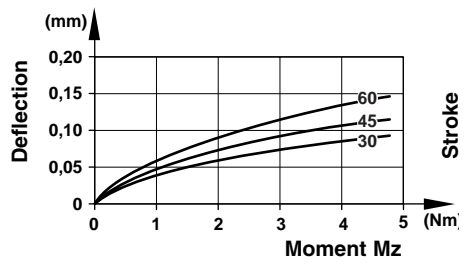

Ø 15 mm

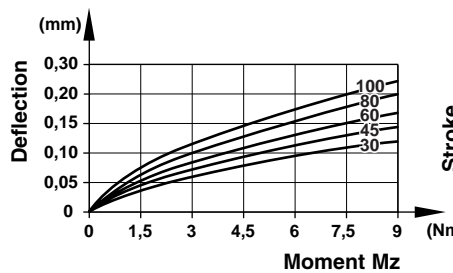

Ø 20 mm

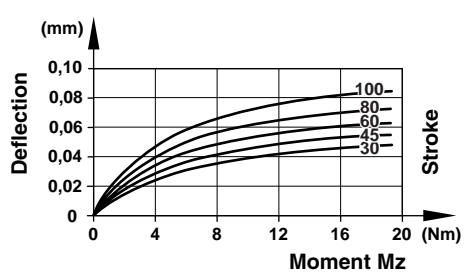



M/2612../R/I Standard slide tables (Ø 8 & 10 mm)

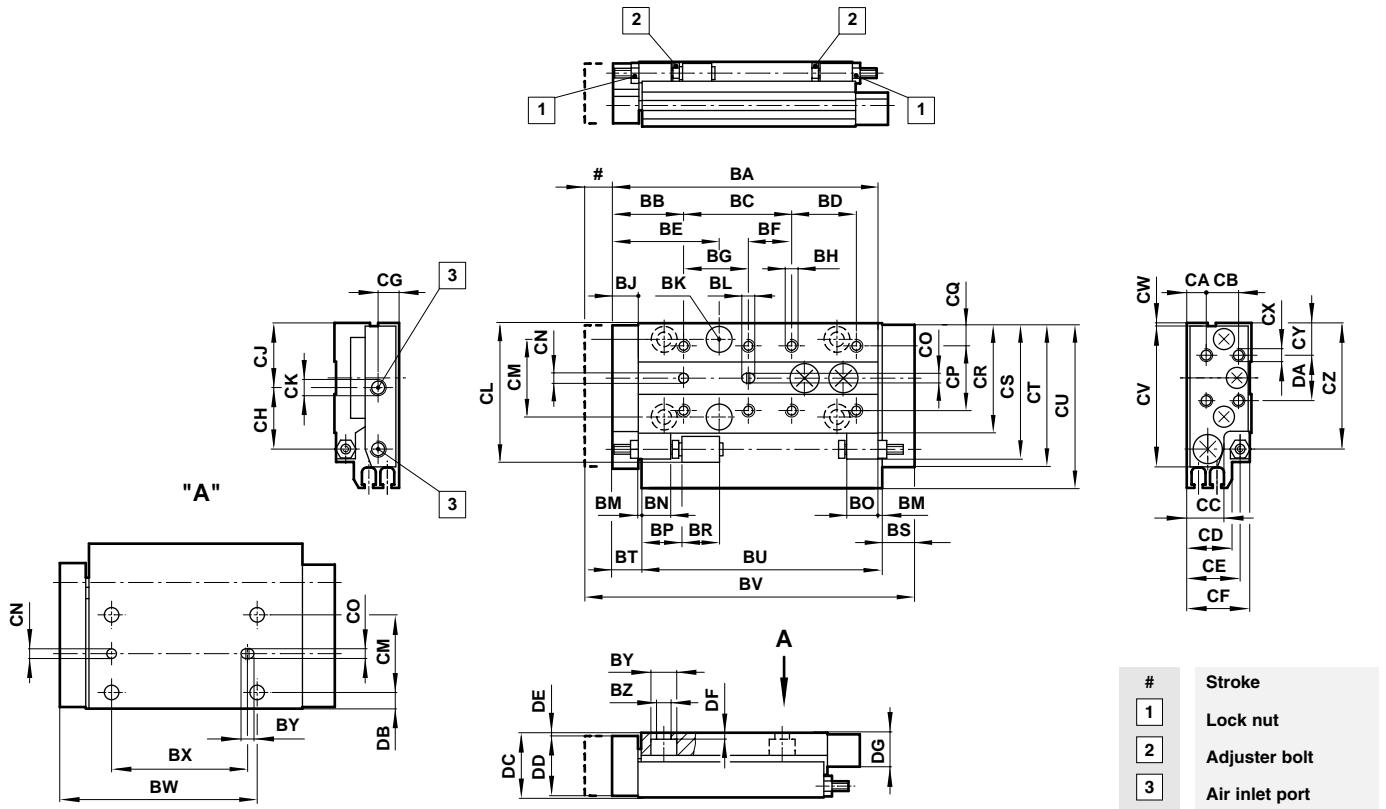

Model	Ø	BB	BD	BH	BJ	Ø BK	BL	BM	BN	BO	BP	BR	BS	BT	Ø BY	Ø BZ
M/261208/..	8	22	20	M4 x 4 deep	8	8	4	1	9	10	12,5	9	10	9	8	4,5
M/261210/..	10	26	25	M4 x 4 deep	10	8	4	1	9	10	14	14	10	11	8	4,5
Model	Ø	CA	CB	CC	CD	CE	CF	CG	CH	CJ	CK	CL	CM	ØCN #3	ØCO #3	CP
M/261208/..	8	6	10	11,5	14	16,5	19,5	6,5	19	20	M5	43	24	3 x 3 deep	3 x 3 deep	20
M/261210/..	10	6	12	12,5	15	18,5	22,5	7	20	27	M5	52	30	3 x 3 deep	3 x 3 deep	25
Model	Ø	CR	CS	CT	CU	CV	CX	CY	CZ	DA	DB	DC	DD	DE	DF	DG
M/261208/..	8	34	42	44,5	51	44	M4 x 6 deep	10	39	14	5	20	18,5	1	2	10,5
M/261210/..	10	40	51	53,5	60,5	53	M4 x 8 deep	12	47	16	5	23	21,5	1	4	11,5

Model	Ø	Stroke	BA	BC	BE	BF	BG	BU	BV	BW	BX	CW	kg	Magnet kg
M/261208../R/I/30	8	30	74	25	33	-	-	66	85	61	42	0,5	0,196	0,002
M/261208../R/I/45	8	45	89	40	33	20	20	81	100	76	57	0,5	0,231	0,002
M/261208../R/I/60	8	60	89	40	33	35	20	96	115	91	72	0,5	0,266	0,002
M/261210../R/I/30	10	30	84	25	38	-	-	74	95	69	44	0,5	0,390	0,003
M/261210../R/I/45	10	45	99	40	38	15	25	89	110	84	59	0,5	0,405	0,003
M/261210../R/I/60	10	60	114	55	38	30	25	104	125	99	74	0,5	0,420	0,003



M/2612./R/S Symmetric slide tables (Ø 8 and 10 mm)

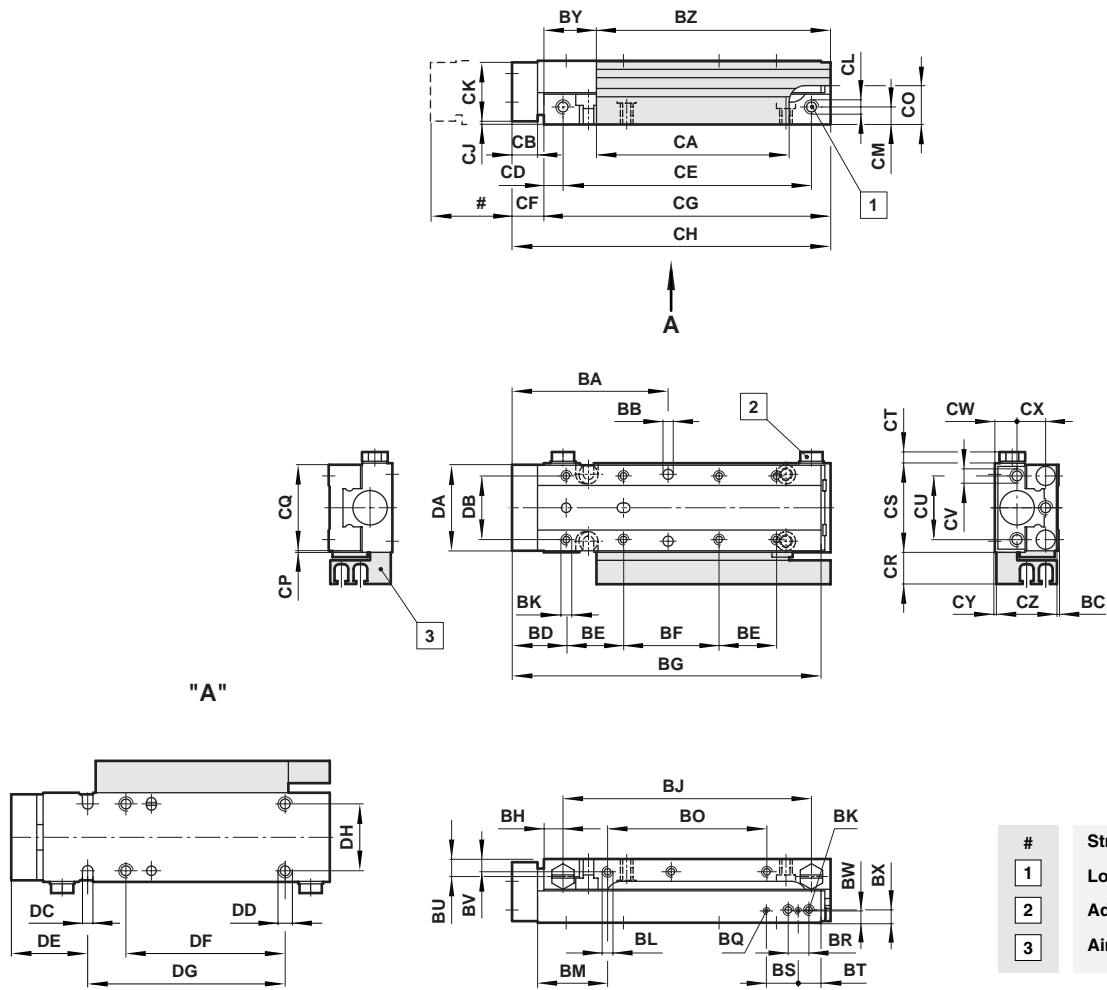

Model	Ø	BB	BD	BH	BJ	Ø BK	BL	BM	BN	BO	BP	BR	BS	BT	Ø BY	Ø BZ
M/261208/..	8	22	20	M4 x 4 deep	8	8	4	1	9	10	12,5	9	10	9	8	4,5
M/261210/..	10	26	25	M4 x 4 deep	10	8	4	1	9	10	14	14	10	11	8	4,5
Model	Ø	CA	CB	CC	CD	CE	CF	CG	CH	CJ	CK	CL	CM	Ø CN #	Ø CO #	CP
M/261208/..	8	6	10	11,5	14	16,5	19,5	6,5	19	20	M5	43	24	3 x 3 deep	3 x 3 deep	20
M/261210/..	10	6	12	12,5	15	18,5	22,5	7	20	27	M5	52	30	3 x 3 deep	3 x 3 deep	25
Model	Ø	CR	CS	CT	CU	CV	CX	CY	CZ	DA	DB	DC	DD	DE	DF	DG
M/261208/..	8	34	42	44,5	51	44	M4 x 6 deep	10	39	14	5	20	18,5	1	2	10,5
M/261210/..	10	40	51	53,5	60,5	53	M4 x 8 deep	12	47	16	5	23	21,5	1	4	11,5

Model	Ø	Stroke	BA	BC	BE	BF	BG	BU	BV	BW	BX	CW	kg	Magnet kg
M/261208./R/S/30	8	30	74	25	33	-	-	66	85	61	42	0,5	0,196	0,002
M/261208./R/S/45	8	45	89	40	33	20	20	81	100	76	57	0,5	0,231	0,002
M/261210./R/S/60	8	60	89	40	33	35	20	96	115	91	72	0,5	0,266	0,002
M/261210./R/S/30	10	30	84	25	38	-	-	74	95	69	44	0,5	0,390	0,003
M/261210./R/S/45	10	45	99	40	38	15	25	89	110	84	59	0,5	0,405	0,003
M/261210./R/S/60	10	60	114	55	38	30	25	104	125	99	74	0,5	0,420	0,003



M/2612../R/ Standard slide tables (Ø 15 & 20 mm)

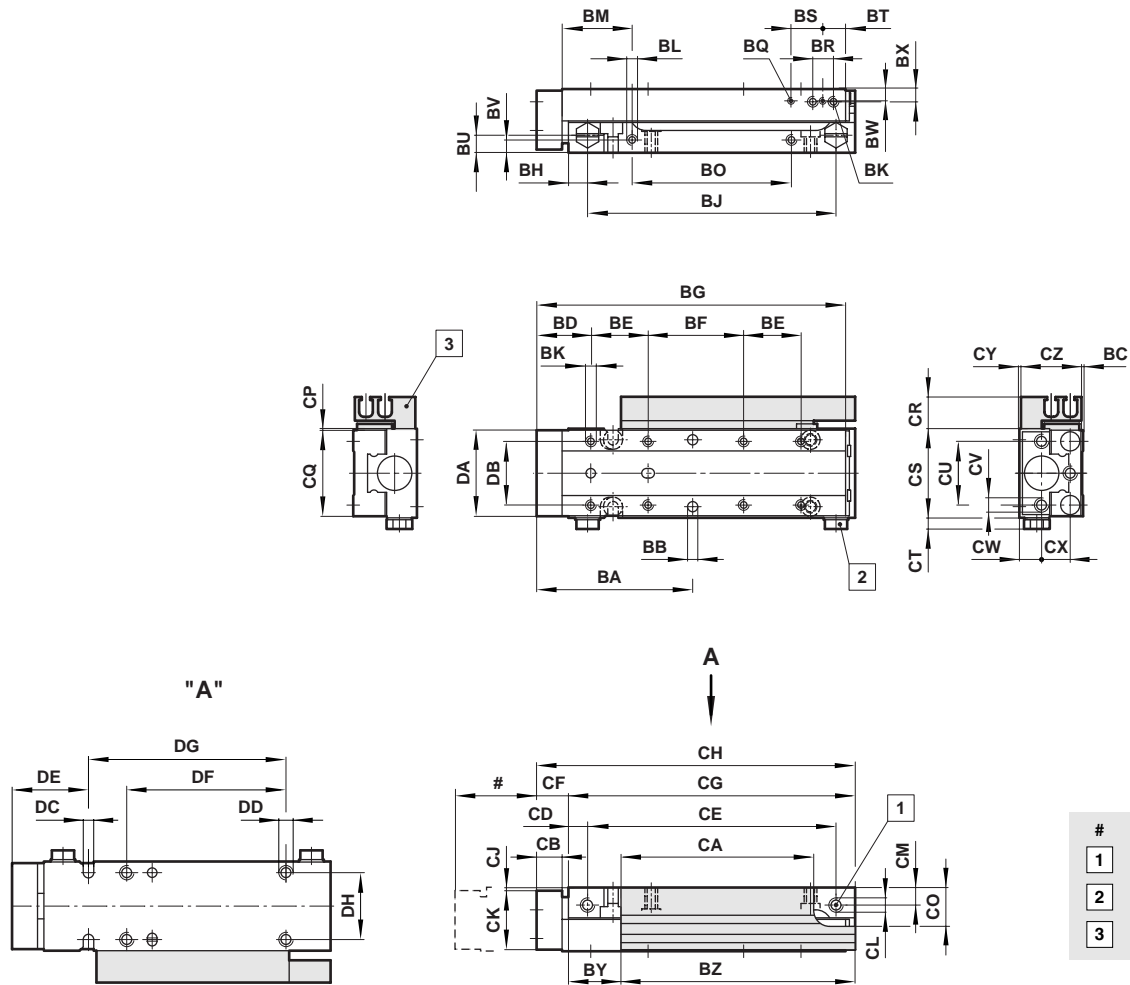

Model	Ø	BB	BD	BH	BJ	Ø BK	BL	BM	BN	BO	BP	BR	BS	BT	ØBY	ØBZ
M/261215/..	15	26	35	M5 x 6 deep	12	10	5	1	13	14	18,5	14	12	13	10	5,5
M/261220/..	20	26	40	M6 x 10 deep	14	13	7	1	19	20	25,5	14	-	15	13	6,5
Model	Ø	CA	CB	CC	CD	CE	CF	CG	CH	CJ	CK	CL	CM	ØCN [®]	ØCO [®]	CP
M/261215/..	15	8	15	18	20	25	29,5	6,5	52	6	M5	64,5	36	4 x 4 deep	4 x 4 deep	35
M/261220/..	20	9	20	20,5	25	32	37,5	6,5	77	8	M5	94	58	6 x 5 deep	6 x 5 deep	60
Model	Ø	CR	CS	CT	CU	CV	CX	CY	CZ	DA	DB	DC	DD	DE	DF	
M/261215/..	15	50	63	-	75,5	68	M5 x 10 deep	20	58	15	7	30	28,5	1	6,5	
M/261220/..	20	74	91	-	104	95	M6 x 12 deep	30	85	22	8	38	36,5	1	5	

Model	Ø	Stroke	BA	BC	BE	BF	BG	BU	BV	BW	BX	CW	kg	Magnet kg
M/261215/R/V/30	15	30	95	25	41	-	-	83	105	77	43	0,5	0,857	0,006
M/261215/R/V/45	15	45	110	40	45	-	-	98	120	92	58	0,5	0,880	0,006
M/261215/R/V/60	15	60	125	55	45	20	35	113	135	107	73	0,5	0,903	0,006
M/261215/R/V/80	15	80	145	75	45	40	35	133	155	127	93	0,5	0,933	0,006
M/261215/R/V/100	15	100	165	95	45	60	35	153	175	147	113	0,5	0,963	0,006
M/261220/R/V/30	20	30	111	35	46,5	-	-	97	124,5	90	65	0,5	1,230	0,007
M/261220/R/V/45	20	45	126	50	52,5	-	-	112	139,5	105	80	0,5	1,378	0,007
M/261220/R/V/60	20	60	141	65	52,5	25	40	127	154,5	120	95	0,5	1,533	0,007
M/261220/R/V/80	20	80	161	85	52,5	45	40	147	174,5	140	115	0,5	1,736	0,007
M/261220/R/V/100	20	100	181	105	52,5	65	40	167	194,5	160	135	0,5	1,939	0,007



M/2612../R/S Symmetric slide tables (Ø 15 & 20 mm)

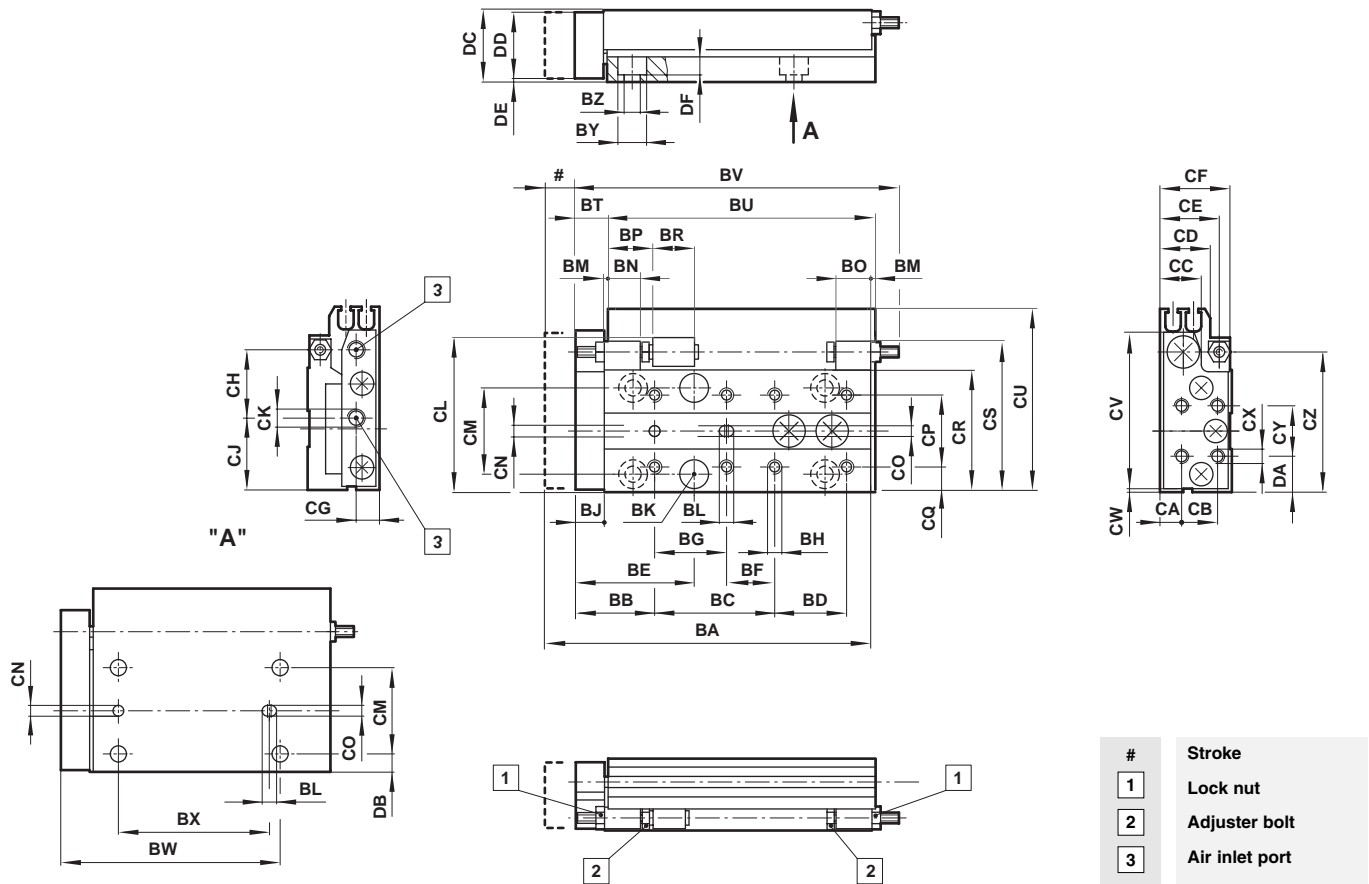

Model	Ø	BB	BD	BH	BJ	Ø BK	BL	BM	BN	BO	BP	BR	BS	BT	ØBY	ØBZ
M/261215/..	15	26	35	M5 x 6 deep	12	10	5	1	13	14	18,5	14	12	13	10	5,5
M/261220/..	20	26	40	M6 x 10 deep	14	13	7	1	19	20	25,5	14	-	15	13	6,5
Model	Ø	CA	CB	CC	CD	CE	CF	CG	CH	CJ	CK	CL	CM	ØCN ^{#3}	ØCO ^{#3}	CP
M/261215/..	15	8	15	18	20	25	29,5	6,5	52	6	M5	64,5	36	4 x 4 deep	4 x 4 deep	35
M/261220/..	20	9	20	20,5	25	32	37,5	6,5	77	8	M5	94	58	6 x 5 deep	6 x 5 deep	60
Model	Ø	CR	CS	CT	CU	CV	CX	CY	CZ	DA	DB	DC	DD	DE	DF	
M/261215/..	15	50	63	-	75,5	68	M5 x 10 deep	20	58	15	7	30	28,5	1	6,5	
M/261220/..	20	74	91	-	104	95	M6 x 12 deep	30	85	22	8	38	36,5	1	5	

Model	Ø	Stroke	BA	BC	BE	BF	BG	BU	BV	BW	BX	CW	kg	Magnet kg
M/261215./R/S/30	15	30	95	25	41	-	-	83	105	77	43	0,5	0,857	0,006
M/261215./R/S/45	15	45	110	40	45	-	-	98	120	92	58	0,5	0,880	0,006
M/261215./R/S/60	15	60	125	55	45	20	35	113	135	107	73	0,5	0,903	0,006
M/261215./R/S/80	15	80	145	75	45	40	35	133	155	127	93	0,5	0,933	0,006
M/261215./R/S/100	15	100	165	95	45	60	35	153	175	147	113	0,5	0,963	0,006
M/261220./R/S/30	20	30	111	35	46,5	-	-	97	124,5	90	65	0,5	1,230	0,007
M/261220./R/S/45	20	45	126	50	52,5	-	-	112	139,5	105	80	0,5	1,378	0,007
M/261220./R/S/60	20	60	141	65	52,5	25	40	127	154,5	120	95	0,5	1,533	0,007
M/261220./R/S/80	20	80	161	85	52,5	45	40	147	174,5	140	115	0,5	1,736	0,007
M/261220./R/S/100	20	100	181	105	52,5	65	40	167	194,5	160	135	0,5	1,939	0,007



Switches

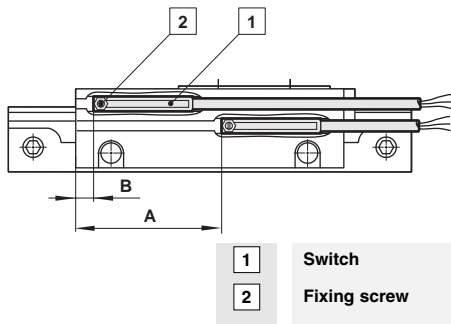

Reed

Ø mm	Setting position	
	A	B
8	31	4
10	31	12
15	32	19
20	33	32

Solid state

Ø mm	Setting position	
	A	B
8	29	6
10	29	14
15	30	21
20	31	34

Warning

These products are intended for use in industrial compressed air systems only. Do not use these products where pressures and temperatures can exceed those listed under 'Technical Data'.

Before using these products with fluids other than those specified, for non-industrial applications, life-support systems, or other applications not within published specifications, consult **NORGREN**.

Through misuse, age, or malfunction, components used in fluid power systems can fail in various modes.

The system designer is warned to consider the failure modes of all component parts used in fluid power systems and to provide adequate safeguards to prevent personal injury or damage to equipment in the event of such failure.

System designers must provide a warning to end users in the system instructional manual if protection against a failure mode cannot be adequately provided.

System designers and end users are cautioned to review specific warnings found in instruction sheets packed and shipped with these products.