

**Inline 3/2, 5/2 and 5/3 Spool Valves
Solenoid and Pilot Actuated
G^{1/2}**

- Low power solenoids
- High flow
- Unique steel reinforced seals
- Light weight corrosion resistant materials

Technical Data

Medium:

Compressed air, filtered, lubricated and non-lubricated

Operation:

Spool Valve, directly actuated

Mounting:

Through-holes in valve body

Port Size:

G^{1/2}

Operating Pressure:

Maximum 10 bar. For details see overleaf.

Flow Characteristics:

	'C'	'b'	'A'	l/min	Cv	Kv
M/20134/***	14,28	0,4	57	3,450	3,5	3,04
M/20154/***	14,28	0,4	57	3,450	3,5	3,04

Operating Temperature:

-20°C* to +80°C (for solenoid models, +5°C* to +50°C)

*Consult our Technical Service for use below +2°C

Materials

Aluminium valve body and spool, nitrile rubber seals.

Ordering Information

To order, quote model number followed by voltage code from table overleaf. eg. M/20154/22/136 for a solenoid actuated, spring return model with an external pilot supply and suitable for an electricity supply of 42-48v 50/60Hz.



3/2

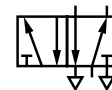

5/2

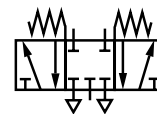

5/3
All Ports Blocked mid position

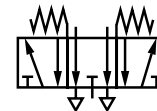

5/3
Centre Open Exhaust

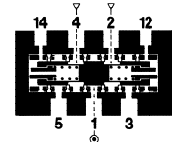
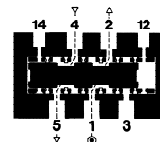
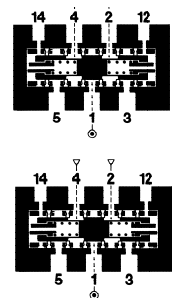
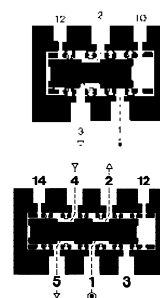



General Information

3/2, 5/2 and 5/3 Solenoid and Pilot Actuated Valves

Symbol	Model	Manual Override	Pilot Supply	Operator	Mid Return	Return	Operating Pressure (bar)	Pilot Pressure (bar)	Weight (Kg)	Spares Kit
	M/20134/122/MD	Turn to lock	Internal	Solenoid	-	Spring	2,5 - 10	-	0,78	QM/20132/122/D/00
	M/20134/3	Turn to lock	External	Pilot	-	Pilot	1,3 - 10	1,3+ (0,1xOP)	1,25	QM/20134/3/00
	M/20134/40	Turn to lock	External	Pilot	-	Pilot	2 - 10	2+ (0,1xOP)	1,25	QM/20134/40/00
	M/20154/22/MD	Turn to lock	External	Solenoid	-	Spring	2 - 10	2+ (0,1xOP)	1,25	QM/20154/22/00
	M/20154/23/MD	Turn to lock	External	Solenoid	-	Solenoid	1,7 - 10	1,7 + (1,2 X OP)*	1,23	QM/21054/123/00
	M/20154/172/MD	Turn to lock	Internal	Solenoid	-	Spring and Air	2,5 - 10	-	1,12	QM/20154/172/00
	M/20154/123/MD	Turn to lock	Internal	Solenoid	-	Solenoid	2,8 - 10	-	1,23	QM/20154/123/00
	M/20154/6123/MD	Turn to lock	Internal	Solenoid	APB	Solenoid	2,8 - 10	-	1,23	QM/20154/6123/00
	M/20254/6123/MD	Turn to lock	Internal	Solenoid	COE	Solenoid	2,8 - 10	-	1,23	QM/20254/6123/00
	M/20154/40	-	-	Pilot	-	Spring	2 - 10	2 + (0,1 X OP)*	1,15	QM/20154/40/00
	M/20154/3	-	-	Pilot	-	Pilot	1,7 - 10	1,7 + (0,2 X OP)*	1,01	QM/20154/3/00
	M/20154/33	-	-	Pilot Priority	-	Pilot	2,5 - 10	2,5 + (0,1 X OP)	1,01	QM/2015433/00
	M/20154/63	-	-	Pilot	APB	Pilot	2,8 - 10	2,8 + (0,1 X OP)*	1,01	QM/20154/63/00
	M/20254/63	-	-	Pilot	COE	Pilot	2,8 - 10	2,8 + (0,1 X OP)*	1,01	QM/20154/63/00

APB = All Ports Blocked COE = Centre Open Exhaust OP = Operating Pressure

Note 1: For pilot priority valve

For port '12' at zero - port '14' = 1,5 + (0,05 x OP) bar
 For port '14' at zero - port '12' = 2,2 + (0,1 x OP) bar
 For permanent supply to port '12' - port '14' = 1,5 + (0,7 x OP) bar

† Valve model M/20134/122/D can also be used as a normally open valve.
 For normally open operation, rotate top plate 180°



Electrical Details for Solenoid Operators

Voltage	Codes
6V d.c (low power)	159
12V d.c (low power)	160
12V d.c	16
24V d.c. (low power)	127
24V d.c	10
42-48V d.c	157
48V d.c (low power)	161
110V d.c (low power)	162
110-120 V d.c	158
12 V 50Hz (low power)	163
24 V 50Hz (low power)	164
24V 50/60Hz	81
42-48V 50/60Hz	136
48V 50Hz (low power)	165
110V 50Hz (low power)	166
110-120V 50Hz	131
220V 50Hz (low power)	167
220-240V 50/60Hz	137

Voltage Tolerance:	d.c.: +10/-15%, a.c.: +10/-15%
Power d.c:	2 W
Power a.c. (Inrush/Hold):	4/2,5 VA (9/5 VA on 220/240V) 100% E.D.
Inlet Orifice:	1,0 mm
Exhaust Orifice:	2,0 mm, 1,1 (low power)
Terminal Box:	3 pin plug with cable grip (DIN 43 650 Form B) May be rotated 180°
Cable Entry:	Pg 9
Solenoid Coil:	May be rotated at 90° intervals.
Manual Override:	Standard, turn 180° anti-clockwise to operate, turn clockwise to return
Protection Class:	IP 65 (DIN 40 050)

Warning

These products are intended for use in industrial compressed air systems only. Do not use these products where *pressures* and *temperatures* can exceed those listed under '**Technical Data**'.

Before using these products with fluids other than those specified, for non-industrial applications, life-support systems, or other applications not within published specifications, consult Norgren.

Through misuse, age, or malfunction, components used in fluid power systems can fail in various modes. The system designer is warned to consider the failure modes of all component parts used in fluid power systems and to provide adequate safeguards to prevent personal injury or damage to equipment in the event of such failure.

System designers must provide a warning to end users in the system instructional manual if protection against a failure mode cannot be adequately provided.

System designers and end users are cautioned to review specific warnings found in instruction sheets packed and shipped with these products where applicable.



M/20134/122/MD
3/2 Single Solenoid Valve

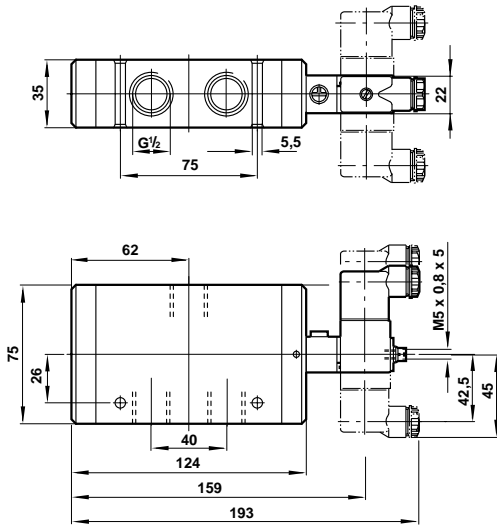

M/20154/22/MD
5/2 Single Solenoid Valve

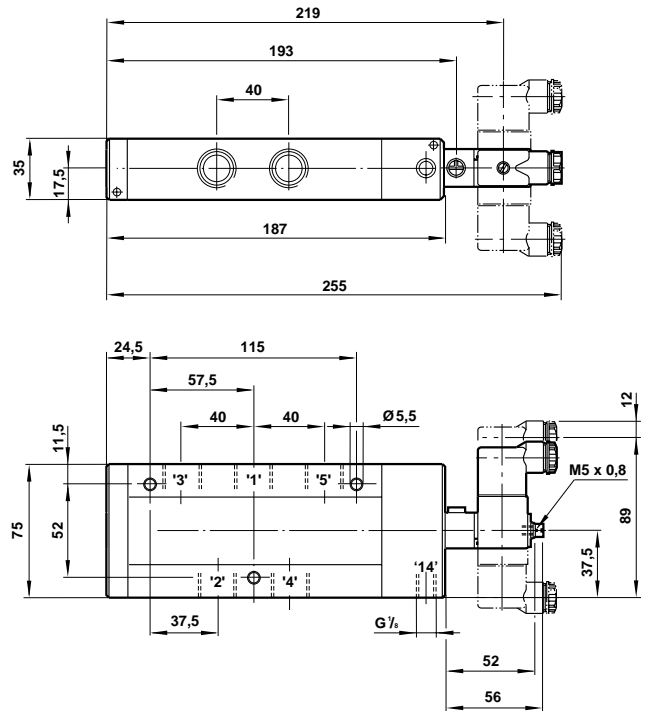

M/20154/172/MD
5/2 Single Solenoid Valve

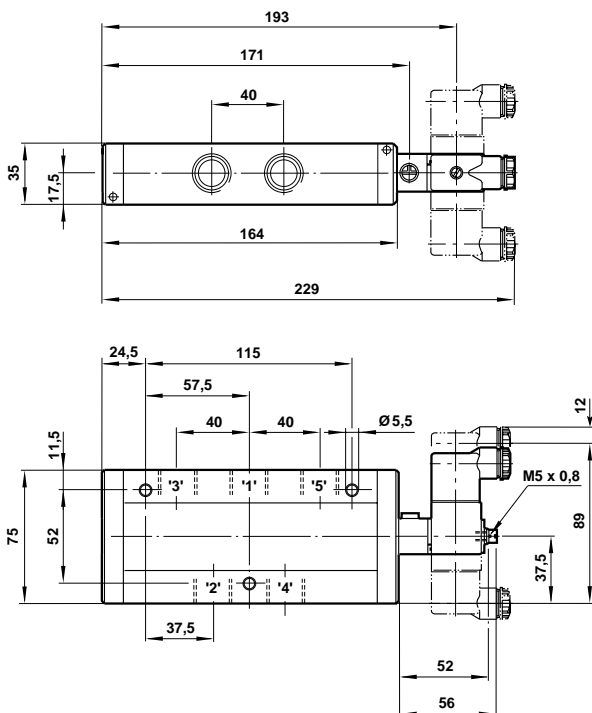

M/20154/23/MD & M/20154/123/MD Models
5/2 Double Solenoid Valves

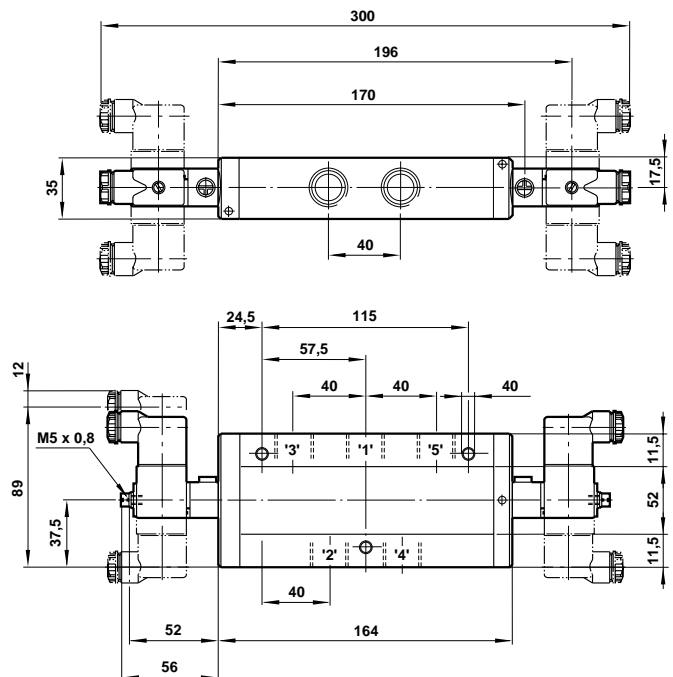



M/20154/6123/MD & M/20256/6123/MD Models
5/2 Double Solenoid Valves

M/20154/40
5/2 Single Pilot Valve

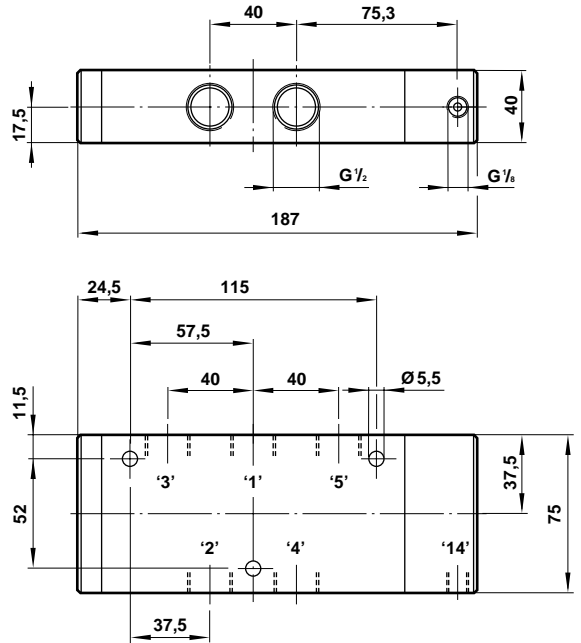
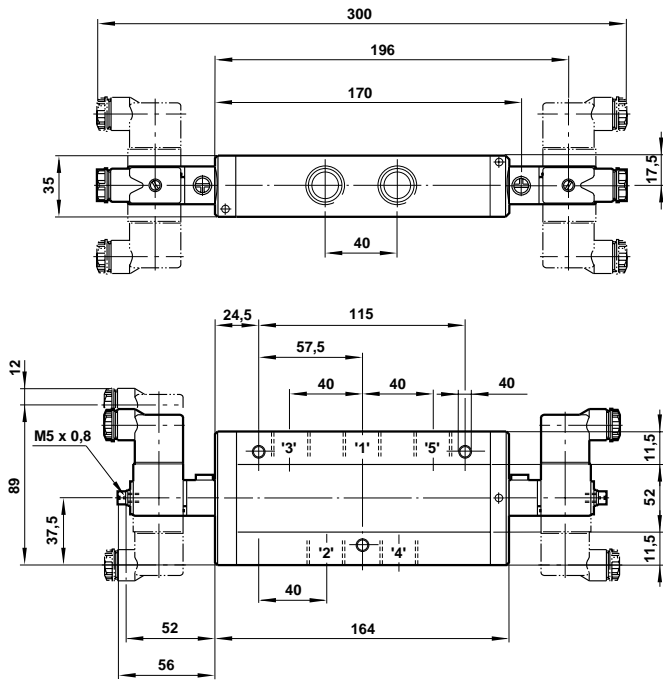

M/20154/172, M/20154/63 & M/20654/63 Models
5/2, 5/3 Double Pilot Valves

M/20134/3 & M/20134/40
Pressure Set-reset, Pressure Actuated, Spring Return

