



- **Versatile system easily expandable**
- **Dedicated modules linked to Nugget Valve Islands**
- **Overall Fieldbus control achieved via gateway**
- **Complete range of accessories**
- **EMC compliant (Directive 89/336/EEC)**



#### **Technical Data**

Protocol:

AS-Interface:

4 inputs/outputs per module

(Special 4 inputs/outputs modules also available)

Bus Topology:

Tree, Star, Ring or Line with spurs

System configuration:

Single master, multi-slaves

Communication:

AS-Interface

Max baud rate:

5ms cycle time with 31 slaves

Cable length at max baud rate:

100m +100m per repeater

Number of units per AS-I network:

Master + 31 slaves

(62 slaves with double master controller)

Addressing:

Set on controller or by hand held unit

Cable:

AS-I Line Yellow

Power Black

Voltage:

Power: 24V d.c.

Communication (AS-I line): 29.6V d.c.

Operating Temperature:

-25° to +80°C (modules)

#### **Ordering Information**

Consult tables on following pages.

To order AS-Interface Valve Islands refer to the Nugget 40 Valve Island data sheet (5.4.112) and Nugget 120 Valve Island data sheet (5.4.156).





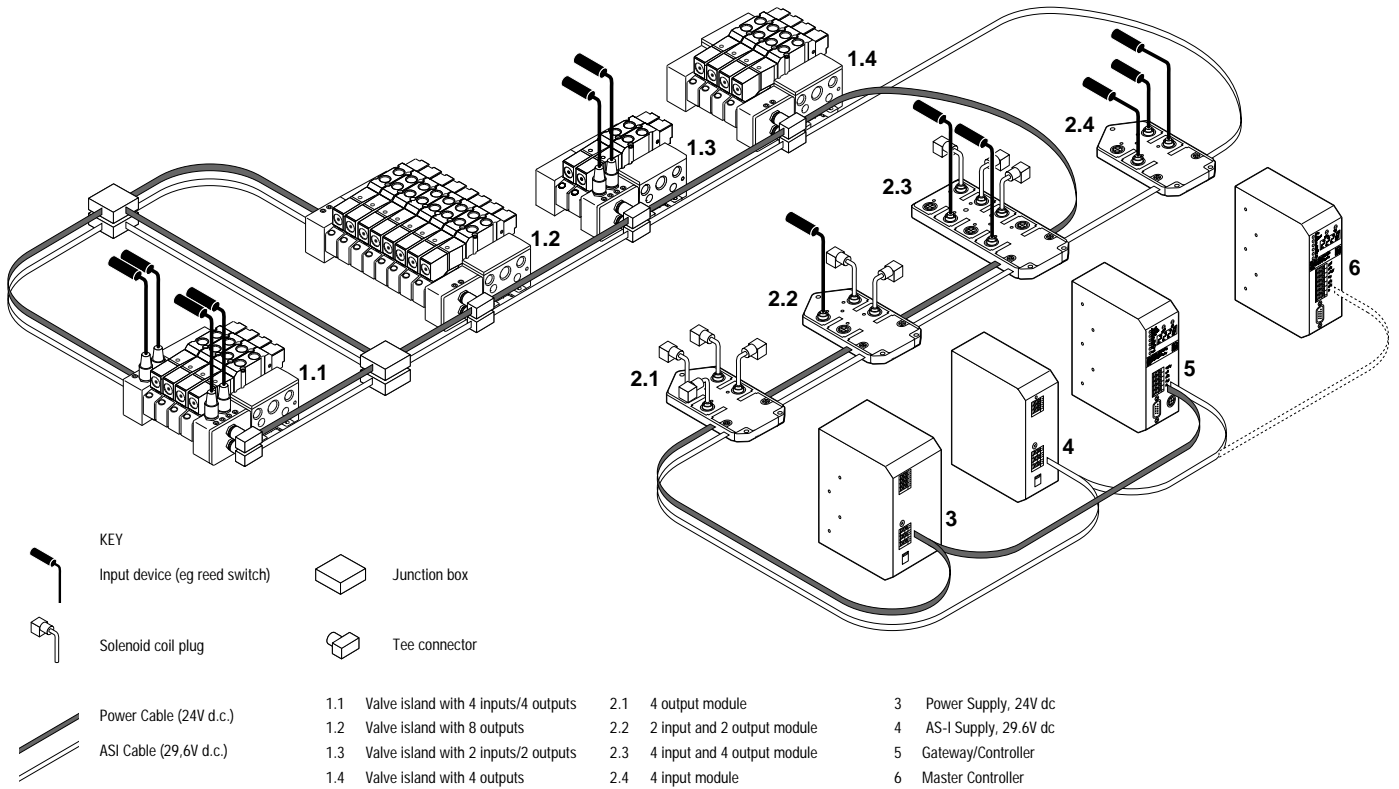







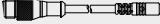

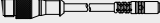
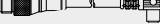
# AS-Interface Bus System



Group	Item	Description	Part Number	Detail Page Number	
<b>1</b>		Valve Islands with integral AS-I Modules		5.4.112.09	
		Please refer to data sheets 5.4.112 (Nugget 40 Valve Islands) and 5.4.156 (Nugget 120 Valve Islands)		5.4.112.09 5.4.156.09 5.4.156.09	
<b>2</b>		Input/Output Modules			
		2.1	4 Output module	VE1AS001-00400	6.4.010.04
		2.2	2 Input + 2 Output module	VE1AS001-20200	6.4.010.04
		2.3	4 Input + 4 Output module	VE1AS001-40400	6.4.010.04
		2.4	4 Input module	VE1AS001-40000	6.4.010.04
<b>3</b>		Power Supply for 24V d.c.			
		3.1	115/230V a.c. → 24V d.c. 2.5A	VE1ASPS2-06019	6.4.010.06
		3.2	115/230V a.c. → 24V d.c. 5A	VE1ASPS2-12019	6.4.010.06
		3.3	115/230V a.c. → 24V d.c. 10A	VE1ASPS2-24019	6.4.010.06
<b>4</b>		AS-I Supply for 29.6V d.c. (communication)			
		4.1	115/230V a.c. → 29.6V d.c. 85W	VE1ASPS1-08519	6.4.010.08
		4.2	24V d.c. → 29.6V d.c. 85W	VE1ASPS1-08513	6.4.010.08
		4.3	115/230V a.c. → 29.6V d.c. 180W	VE1ASPS1-18019	6.4.010.08
		4.4	115/230V a.c. → 29.6V d.c. + 24V d.c. 180W (combined)	VE1ASPS3-18019	6.4.010.08
<b>5</b>		Gateway/Controller			
		5.1	Profibus DP 1 Master card (31 slaves)	VA1ASCT1-DP000	6.4.010.10
		5.2	Profibus DP 2 Master cards (62 slaves)	VA1ASCT2-DP000	6.4.010.10
		5.3	Devicenet 1 Master card (31 slaves)	VA1ASCT1-DNT00	6.4.010.10
		5.4	Interbus S 1 Master card (31 slaves)	VE1ASCT1-IBS00	6.4.010.12
<b>6</b>		Master Controller			
		6.1	1 Master card (31 slaves)	VE1ASCT1-RS232	6.4.010.14
		6.2	2 Master cards (62 slaves)	VE1ASCT2-RS232	6.4.010.14



## Accessories

Symbol	Description	Connection size	Straight/Elbow	Cable Length (metres)	Part Number	Page Number
	<b>Output M12 plug and cable assemblies for solenoid coils</b>					
	Wireable 5 pin male plug – screw termination	M12	Straight	-	VE1FBCRS-M125P	6.4.010.17
	Connecting cable – 5 pin plug to valve connection – Type C (15mm coil)	M12	Straight	-	VE1FBCSC-M1203	6.4.010.17
	Connecting cable – 5 pin plug to valve connection – Type C (15mm coil)	M12	Straight	0,3	VE1FBCSC-M1210	6.4.010.17
	Connecting cable – 5 pin plug to valve connection – Industrial (22mm coil)	M12	Straight	1,0	VE1FBCSB-M1203	6.4.010.17
	Connecting cable – 5 pin plug to valve connection – Industrial (22mm coil)	M12	Straight	0,3	VE1FBCSB-M1210	6.4.010.17
	Connecting cable – 5 pin plug to valve connection – Type A (32mm coil)	M12	Straight	1,0	VE1FBCSA-M1203	6.4.010.17
	Connecting cable – 5 pin plug to valve connection – Type A (32mm coil)	M12	Straight	0,3	VE1FBCSA-M1210	6.4.010.17
	<b>Input/sensor and drop line plug and cable assemblies</b>					
	Wireable 5 pin male input sensor plug – screw termination	M12	Straight	-	VE1FBCRS-M125P	6.4.010.17
	Connecting cable – 3 pin plug to 3 pin socket	M12/Ø8	Straight/Straight	1	VE1FBC8S-M1210	6.4.010.18
	Connecting cable – 3 pin plug to 3 pin socket	M12/Ø8	Straight/Straight	3	VE1FBC8S-M1230	6.4.010.18
	Connecting cable – 3 pin plug to 3 pin socket	M12/Ø8	Straight/Straight	5	VE1FBC8S-M1250	6.4.010.18
	Connecting cable – 3 pin plug to 3 pin socket	M12/Ø8	Straight/Elbow	1	VE1FBC8E-M1210	6.4.010.18
	Connecting cable – 3 pin plug to 3 pin socket	M12/Ø8	Straight/Elbow	3	VE1FBC8E-M1230	6.4.010.18
	Connecting cable – 3 pin plug to 3 pin socket	M12/Ø8	Straight/Elbow	5	VE1FBC8E-M1250	6.4.010.18
	Connecting cable – 4 pin plug to 4 pin socket (for drop line too)	M12/M12	Straight/Straight	1	VE1FBC0S-M1210	6.4.010.18
	Connecting cable – 4 pin plug to 4 pin socket (for drop line too)	M12/M12	Straight/Straight	3	VE1FBC0S-M1230	6.4.010.18
	Connecting cable – 4 pin plug to 4 pin socket (for drop line too)	M12/M12	Straight/Straight	5	VE1FBC0S-M1250	6.4.010.18
	<b>Tee Connector</b>					
	Tee connector for ASI communication or power cable to M12 female	M12			VE1ASCN1-M1200	6.4.010.18
	<b>Blanking Plugs</b>					
	Blanking plug for unused M12 connectors	M12			VE1FBCBK-M1200	6.4.010.18
	<b>Installation cables for AS-Interface systems</b>					
	YM5 flat yellow cable (thermoplastic elastomer)			25, 50, 100m	VE1ASCAY-YMXXX	6.4.010.19
	YM5 flat black cable (thermoplastic elastomer)			25, 50, 100m	VE1ASCAB-YMXXX	6.4.010.19
	<b>Clip for ASI cable</b>					
	Cable clip for 1 cable (quantity 100)				VE1ASAC1-CL001	6.4.010.19
	<b>Programming cable</b>					
	To connect RS-232C coupler from AS-I Controller with PC socket to socket sub D9 pin			2	VE1ASPRG-PCETL	6.4.010.19
	<b>Junction Box</b>					
	For cable junctions			-	VE1ASCN1-JB001	6.4.010.19
	<b>Hand held addressing unit</b>					
	For addressing connected modules, intelligent sensors and actuators			-	VE1ASHP1-00000	6.4.010.19
	<b>Software and Handbook</b>					
	Software and Handbook – English			-	VE1ASMA1-E0000	6.4.010.16
	Software and Handbook – German			-	VE1ASMA1-G0000	6.4.010.16



**Group 2**  
**Input/Output Modules**

- 2.1 VE1AS001-40000 4 Input Module
- 2.2 VE1AS001-20200 2 Input and 2 Output Module
- 2.4 VE1AS001-00400 4 Output Module

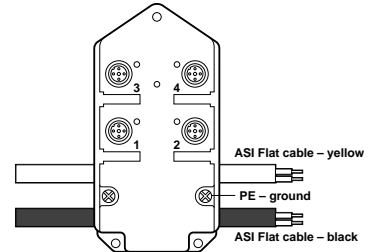
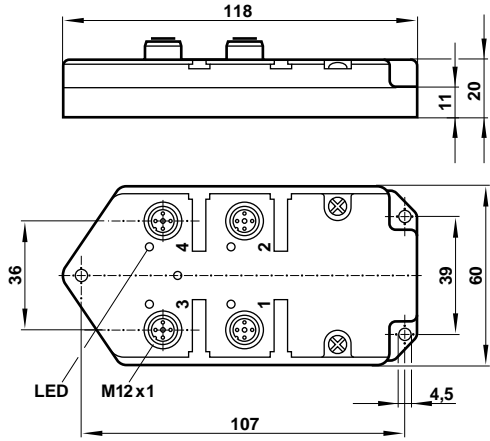

2.3 VE1AS001-40400 4 Input and 4 Output Module

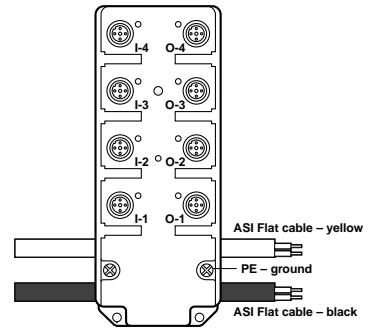
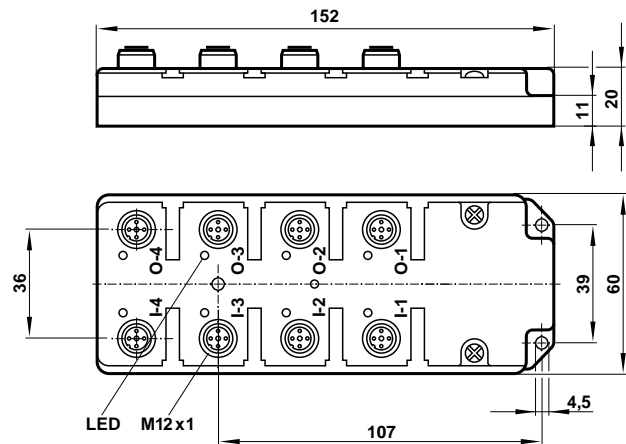

4 Pin input connection

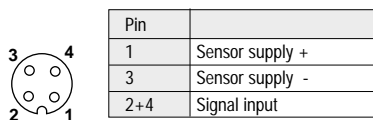

Module/Socket view

3 Pin output connection

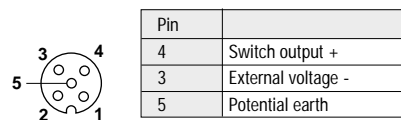

Module/Socket view

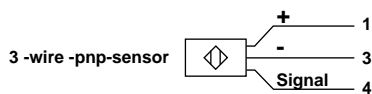



## Group 2 Input/Output Modules

### Technical Specification

Description	2.1 (4 Inputs) VE1AS001-40000	2.2 (2 Inputs and 2 Outputs) VE1AS001-20200	2.4 (4 Outputs) VE1AS001-00400	2.3 (4 Inputs and 4 Outputs) VE1AS001-40400
Operating voltage according to AS-I specification	26,5 to 32,6V d.c.	26,5 to 32,6V d.c.	26,5 to 32,6V d.c.	26,5 to 32,6V d.c.
Total current consumption	≤ 130mA	≤ 130mA	≤ 75mA	≤ 135mA
Input circuit	PNP	PNP	-	PNP
Inputs: Sensor supply Voltage range Maximum current load for all inputs total Short circuit protected Switch level high signal Input current (high/low)	✓ 20 to 30V d.c. 100mA ✓ ≥10V ≥5 / ≤1,5mA	✓ 20 to 30V d.c. 100mA ✓ ≥10V ≥5 / ≤1,5mA	- - - - -	✓ 20 to 30V d.c. 100mA ✓ ≥10V ≥5 / ≤1,5mA
Outputs: Galvanically isolated Short circuit protected Watchdog Maximum current load per o/p Voltage supply	- - - - -	✓ ✓ ✓ 2A 24V d.c. nominal	✓ ✓ ✓ 2A 24V d.c. nominal	✓ ✓ ✓ 2A 24V d.c. nominal
Reverse polarity protection	✓	✓	✓	✓
AS-I profile	S 0,0	S 3,0	S 8,0	S 7,0
I/O configuration (Hex)	0	3	8	7
ID code (Hex)	0	0	0	0
AS-I certificate	06601	05801	08901	05901
EMC Noise emission Noise immunity	EN 50081-1 EN 50082-2	EN 50081-1 EN 50082-2	EN 50081-1 EN 50082-2	EN 50081-1 EN 50082-2
Protection class	IP 67	IP 67	IP 67	IP 67
Temperature range	-25°C to+80°C	-25°C to+80°C	-25°C to+80°C	-25°C to+80°C
Number of sockets	4	4	4	8
Input/output signal indicators	Yellow LED	Yellow LED	Yellow LED	Yellow LED
AS-I Voltage indicator	Green LED	Green LED	Green LED	Green LED
AS-I Housing material	Polyurethane	Polyurethane	Polyurethane	Polyurethane
Allocation of data bits D0 D1 D2 D3	I-1 I-2 I-3 I-4	I-1 I-2 O-3 O-4	O-1 O-2 O-3 O-4	I-1 / O-1 I-2 / O-2 I-3 / O-3 I-4 / O-4
Connection <b>Caution</b>	Via contact pins in the device base – remove cover for access The acceptable current load of the outputs amounts to max of 4,0A per module Inputs and outputs must be isolated			



### Group 3

#### 24V d.c. Power Supplies for outputs (black cable)

##### 3.1 VE1ASPS2-06019 2,5A

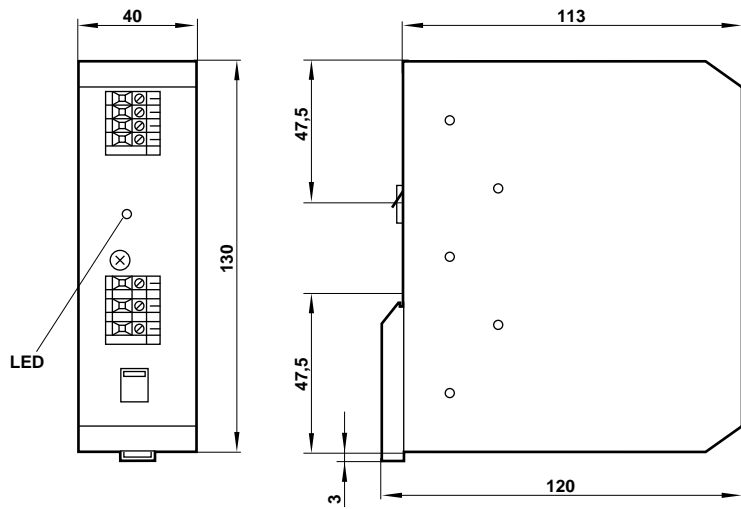

##### 3.2 VE1ASPS2-12019 5A

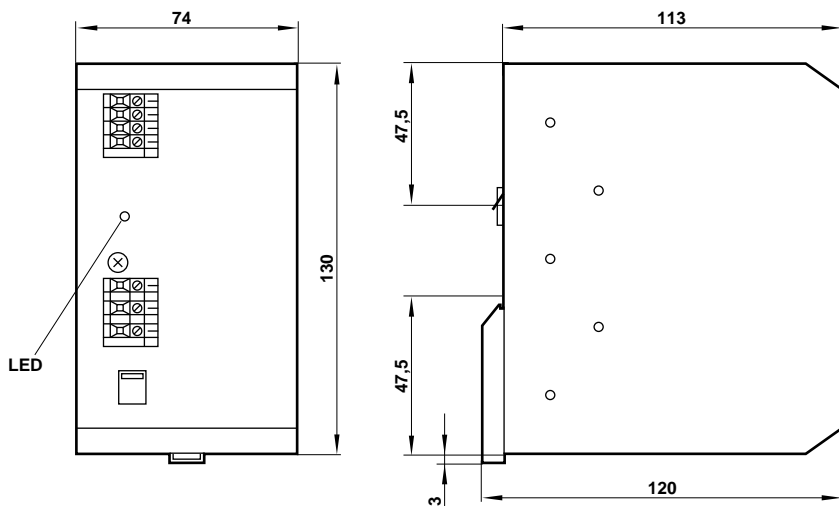

##### 3.3 VE1ASPS2-24019 10A

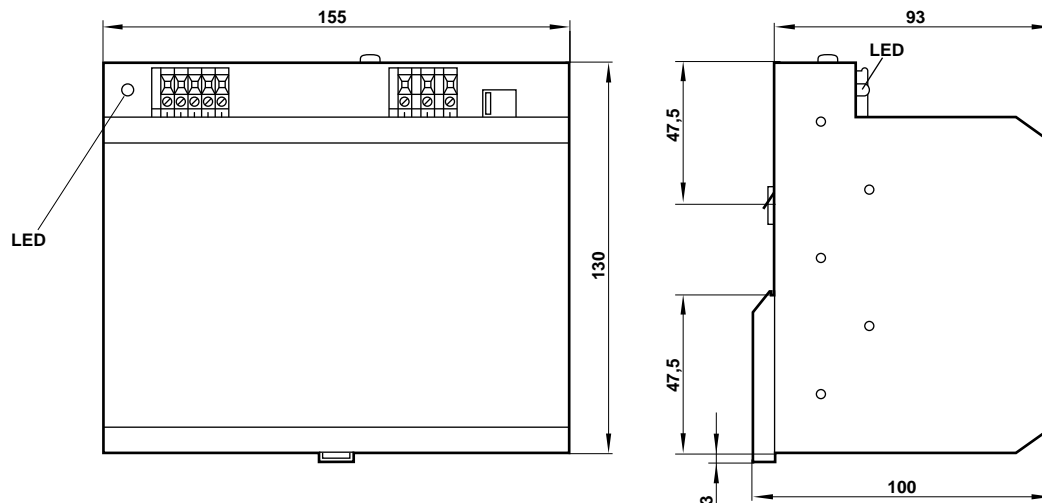



## 24V d.c. Power Supplies

### Technical Specification

Description	3.1 VE1ASPS2-06019 2,5A	3.2 VE1ASPS2-12019 5A	3.3 VE1ASPS2-24019 10A
Output current	2,5A	5A	10A
Nominal voltage	115/230V selectable	115/230V selectable	115/230V selectable
Input voltage range	88-132/187-264Va.c.	88-132/187-264Va.c.	88-132/187-264Va.c.
Nominal frequency	47-63Hz	47-63Hz	47-63Hz
Efficiency	87%	88%	88%
Housing	Aluminium	Aluminium	Aluminium
Protection class	IP20	IP20	IP20
Connection	2,5mm <sup>2</sup> clamps	2,5mm <sup>2</sup> clamps	2,5mm <sup>2</sup> clamps
Temperature range	0°C to +60°C	0°C to +60°C	0°C to +60°C
Derating	≥ 60°C to 70°C	≥ 60°C to 70°C	≥ 60°C to 70°C
Output voltage	24V d.c. ± 2%	24V d.c. ± 2%	24V d.c. ± 2%
High run-time	42ms	30ms	35ms
Residual ripple	≤ 1%	≤ 1%	≤ 1%
Bridgeable power failure time	46ms	27ms	25ms
Peak starting current	14A	16A	50A
Overload proof	✓	✓	✓
Over voltage protection	✓	✓	✓
EMC	✓	✓	✓
Interference suppression	VDE 0871/B EN 55022/B	VDE 0871/B EN 55022/B	VDE 0871/B EN 55022/B
Protection class	1	1	1
Extra low voltage protection	SELV	SELV	SELV
Integrated protection	T2A/250V	T5A/250V	T5A/250V
Weight	460g	640g	1100g
Indicators	Green for output voltage	Green for output voltage	Green for output voltage
Power failure	-	-	Output high at 83>160V
Terminal allocation			



**Group 4**

**AS-I 29.6V d.c. Power Supplies for AS-I Communication and Inputs (yellow cable)**

4.1 VE1ASPS1-08519 85W AS-I supply a.c.

4.2 VE1ASPS1-08513 85W AS-I supply d.c.

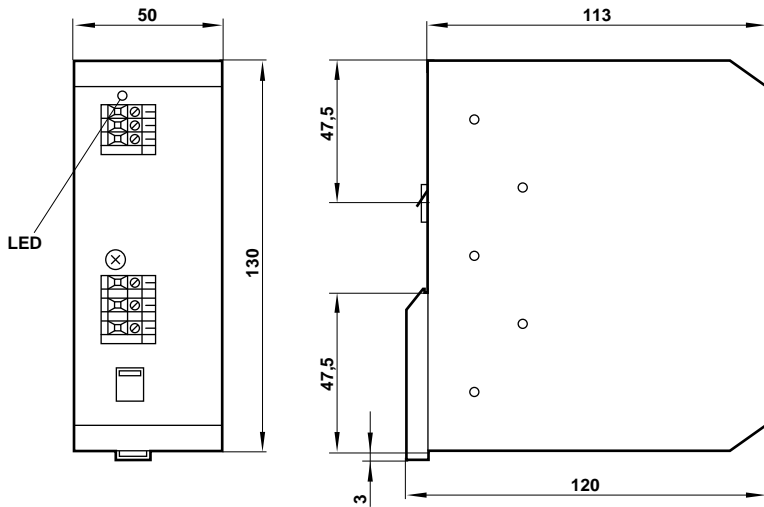

4.3 VE1ASPS1-18019 180W AS-I supply a.c.

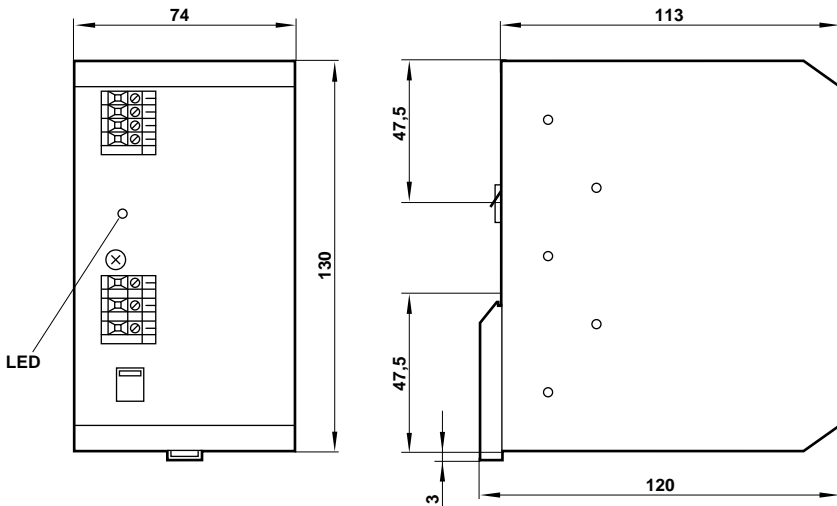

4.4 VE1ASPS3-18019 180W Combined AS-I 29.6V d.c. and 24V d.c. Power Supply

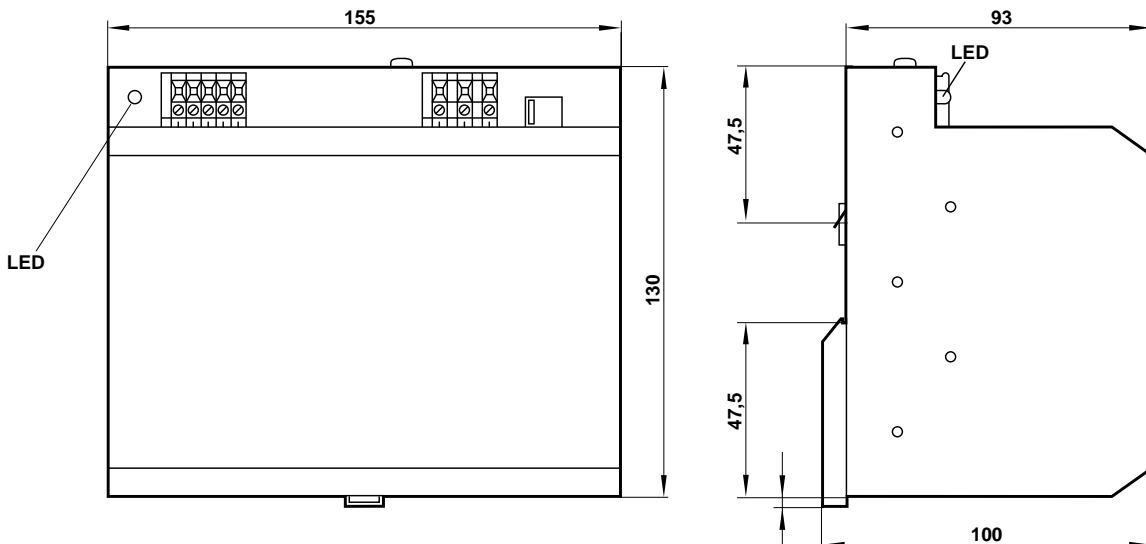





**AS-I 29.6V d.c. Power Supplies for AS-I Communication and Inputs (yellow cable)**

Technical Specification

Description	4.1 VE1ASPS1-08519 85W a.c.	4.2 VE1ASPS1-08513 85W d.c.	4.3 VE1ASPS1-18019 180W a.c.	4.4 VE1ASPS3-18019 180W combined AS-I (29.6V) & output power (24V)
Output current	2,8A	2,8A	8A	2,8/6A
Nominal voltage	115/230Va.c. selectable	24Vd.c.	115/230V selectable	115/230V selectable
Input voltage range	88-132/187-264Va.c.	21,6-26,4Vd.c..	88-132/187-264Va.c.	88-132/187-264Va.c.
Nominal frequency	47-63Hz	-	47-63Hz	47-63Hz
Efficiency	87%	87%	88%	88%
Housing	Aluminium	Aluminium	Aluminium	Aluminium
Protection class	IP20	IP20	IP20	IP20
Connection	2,5mm <sup>2</sup> clamps	2,5mm <sup>2</sup> clamps	2,5mm <sup>2</sup> clamps	2,5mm <sup>2</sup> clamps
Temperature range	0 to +60°C	0°C to +60°C	0°C to +60°C	-10°C to +60°C
Derating	≥ 60°C to 70°C	≥ 60°C to 70°C	≥ 60°C to 70°C	≥ 60°C to 70°C
Output voltage	29,5 to 31,6d.c.	29,5 to 31,6Vd.c.	29,5 to 31,6Vd.c.	29,5 to 31,6Vd.c./24V d.c. ±2%
High run-time	42ms	42ms	30ms	-
Residual ripple	≤ 1%	≤ 1%	≤ 1%	≤ 1%
Bridgeable power failure time	46ms	27ms	25ms	-
Peak starting current	14A	16A	50A	-
Overload proof	✓	✓	✓	✓
Over voltage protection	✓	✓	✓	✓
EMC	✓	✓	✓	✓
Interference suppression	VDE 0871/B; EN 55022/B	VDE 0871/B; EN 55022/B	VDE 0871/B; EN 55022/B	VDE 0871/B; EN 55022/B
Protection class	1	1	1	1
Extra low voltage protection	PELV	PELV	PELV	PELV
Integrated protection	T2A/250V	-	T5A/250V	-
Weight	460g	460g	1100g	-
Approvals	TBA	TBA	TBA	TBA
Indicators	Green for output voltage	Green for output voltage	Green for output voltage	Green for output voltage
Terminal allocation	<p>Secondary { asi ⊕ asi ⊖ Screen Primary { ⊕ L1 Supply N</p>	<p>Secondary { asi ⊕ asi ⊖ Screen Primary { ⊕ ⊖ Supply ⊕</p>	<p>Secondary { asi ⊕ asi ⊖ Screen Primary { ⊕ L1 Supply N</p>	<p>Primary { ⊕ L N N.C. ⊕ 24V dc ⊖ 24V dc Shield ⊕ AS-I ⊖ AS-I</p>



### Group 5

#### Gateway/Controller

For standalone AS-I Control and Gateway connection to other protocols

- 5.1 VA1ASCT1-DP000 AS-I/ProfiBus-DP Gateway Controller (1 master, 31 slaves)
- 5.2 VA1ASCT2-DP000 AS-I/ProfiBus-DP Gateway Controller (2 masters, 62 slaves)

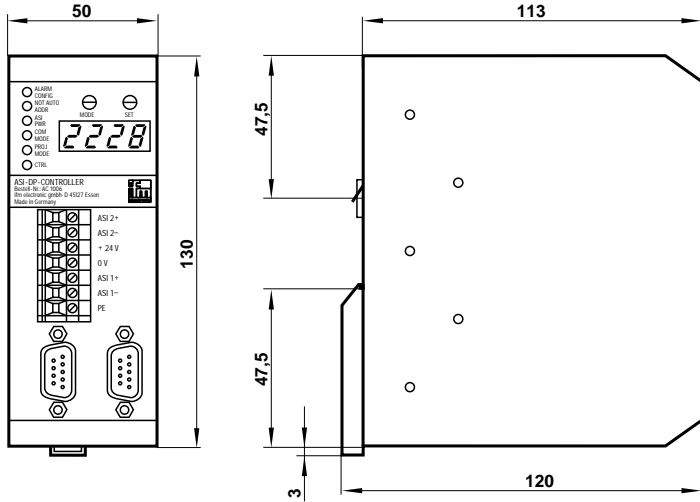

- 5.3 VA1ASCT1-DNT00 AS-I DeviceNet Gateway Controller (1 master, 31 slaves)

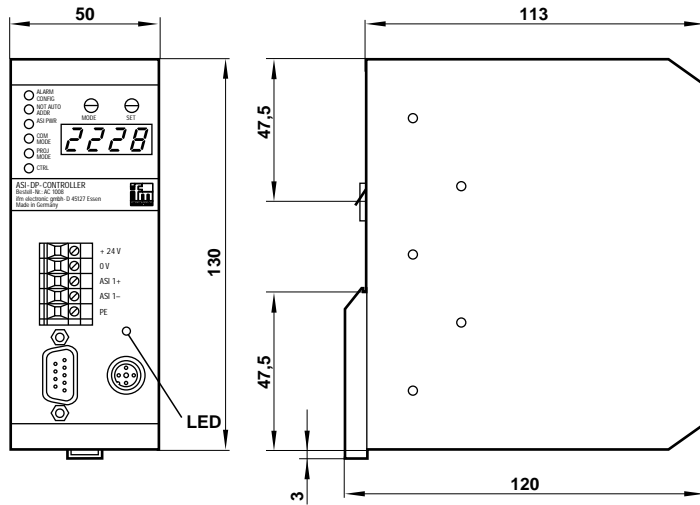

See page 6.4.010.16 for information on AS-I configuration and controller programming software.



Gateway/Controllers

Technical Specification

Description	5.1 VA1ASCT1-DP000 Profibus-DP (1 master)	5.2 VA1ASCT2-DP000 Profibus-DP (2 master)	5.3 VA1ASCT1-DNT00 DeviceNet (1 master)																															
Operating voltage	15-30V d.c. (typ 24V d.c.)	15-30V d.c. (typ 24V d.c.)	15-30V d.c. (typ 24V d.c.)																															
Power consumption	≤ 10W	≤ 10W	≤ 10W																															
Serial interfaces	RS 232 C Transm. rate 4800/62400 baud	RS 232 C Transm. rate 4800/62400 baud	RS 232 C Transm. rate 4800/62400 baud																															
AS-I Interfaces	Specification to AS-I	Specification to AS-I	Specification to AS-I																															
Fieldbus Interface	Profibus-DP to DIN 19245 Part 3	Profibus-DP to DIN 19245 Part 3	DeviceNet																															
No. of screw clamps	5	7	5																															
Function indicator	2 x red, 2 x green, 1 x yellow	2 x red, 2 x green, 1 x yellow	2 x red, 2 x green, 1 x yellow																															
Control buttons	1 x MODE 1 x SET/4-digit LED	1 x MODE 1 x SET/4-digit LED	1 x MODE 1 x SET/4-digit LED																															
Ambient temperature	0°C to +70°C	0°C to +70°C	0°C to +70°C																															
Housing	Clamp rail housing can mount on DIN rails	Clamp rail housing can mount on DIN rails	Clamp rail housing can mount on DIN rails																															
Protection class	Housing: IP20 Terminals: IP20	Housing: IP20 Terminals: IP20	Housing: IP20 Terminals: IP20																															
LED Functions on Control panel	<p>Red Configuration alarm Red Auto addressing blocked Green AS-I power Green Normal operation Yellow Configuration mode Yellow (flashing) Unprotected mode Yellow Controller in RUN mode</p> <p>○ ALARM ○ CONFIG ○ NOT AUTO ○ ADDR ○ MODE ○ SET ○ ASI ○ PWR ○ COM ○ MODE ○ PROJ ○ MODE ○ CTRL</p>																																	
Block diagram																																		
Connection schematic	<p>Clamps 6 and 7 apply only to 3.2 VA1ASCT2-DP000</p> <table border="0"> <tr> <td>7</td> <td>ASI 2+</td> <td rowspan="2">} ASI cable 2 wire</td> </tr> <tr> <td>6</td> <td>ASI 2-</td> </tr> <tr> <td>5</td> <td>+24V</td> <td rowspan="2">} operation voltage</td> </tr> <tr> <td>4</td> <td>0V</td> </tr> <tr> <td>3</td> <td>ASI 1+</td> <td rowspan="2">} ASI cable 1 wire</td> </tr> <tr> <td>2</td> <td>ASI 1-</td> </tr> <tr> <td>1</td> <td>PE</td> <td>Ground</td> </tr> </table> <table border="0"> <tr> <td>5</td> <td>+24V</td> <td rowspan="2">} operation voltage</td> </tr> <tr> <td>4</td> <td>0V</td> </tr> <tr> <td>3</td> <td>ASI +</td> <td rowspan="2">} ASI network</td> </tr> <tr> <td>2</td> <td>ASI -</td> </tr> <tr> <td>1</td> <td>PE</td> <td>Ground</td> </tr> </table>			7	ASI 2+	} ASI cable 2 wire	6	ASI 2-	5	+24V	} operation voltage	4	0V	3	ASI 1+	} ASI cable 1 wire	2	ASI 1-	1	PE	Ground	5	+24V	} operation voltage	4	0V	3	ASI +	} ASI network	2	ASI -	1	PE	Ground
7	ASI 2+	} ASI cable 2 wire																																
6	ASI 2-																																	
5	+24V	} operation voltage																																
4	0V																																	
3	ASI 1+	} ASI cable 1 wire																																
2	ASI 1-																																	
1	PE	Ground																																
5	+24V	} operation voltage																																
4	0V																																	
3	ASI +	} ASI network																																
2	ASI -																																	
1	PE	Ground																																



**Group 5**

**AS-I InterBus-S Gateway Controller**

**5.4 VE1ASCT1-IBS00 AS-I InterBus-S Gateway Controller (1 master, 312 slaves)**

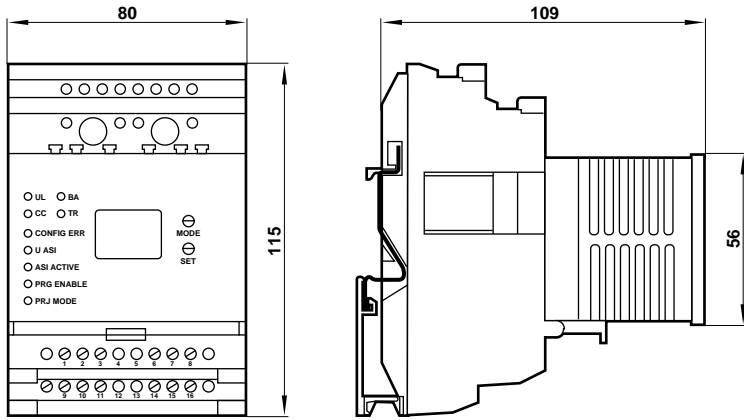

See page 6.4.010.16 for information on AS-I configuration on AS-I configuration and controller programming software.



## AS-I InterBus-S Gateway Controller

### Technical Specification

Description	VE1ASCT1-IBS00
Operating voltage	9V d.c. internal supply via bus terminal
Current consumption	Typ. 220 mA
AS-I Interfaces	✓
Supply via external ASI power supply	✓
No. of ASI slaves (max)	31 + slave 0
No. of digital inputs/outputs Standard operation Bidirectional operation	124 124 inputs and 124 outputs
Operating states Evaluation via program LED display	✓ 2-digit
LCD display	✓
Master function to ASI specification	✓
Data calls	✓
Parameter calls	✓
Address calls	✓
Protection class	IP20
Operating temperature	0°C to +60°C
Note	Access to ASI peripheral equipment in the same way as to InterBus-S peripheral equipment. Existing programs can be used. The ASI-InterBus gateway allows coupling to a variety of control systems: AEG-Modicon, Bosch, Siemens, Allen-Bradley

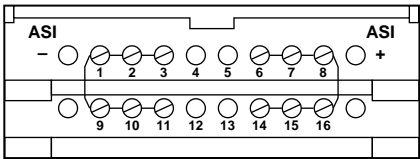
LED Functions on Control panel	<ul style="list-style-type: none"> <li>Green Remote Bus ———— ○ UL — ○ BA</li> <li>Green IBS int supply, one module ———— ○ CC — ○ TR</li> <li>Green ST Cable check ———— ○ CONFIG ERR</li> <li>Green PCP Communication ———— ○ U ASI</li> <li>Red Preset/actual Config different ———— ○ ASI ACTIVE</li> <li>Green ASI supply ———— ○ PRG ENABLE</li> <li>Green Normal operation – data exch ———— ○ PRJ MODE</li> <li>Green Programming mode ————</li> <li>Yellow Planning mode ————</li> </ul> 
Connections  Terminals 4,5,12 and 13 not used	



## Group 6

### AS-I Master Controller

- 6.1 VE1ASCT1-RS232 Controller, 1 master (31 slaves)
- 6.2 VE1ASCT2-RS232 Controller, 2 masters(62 slaves)

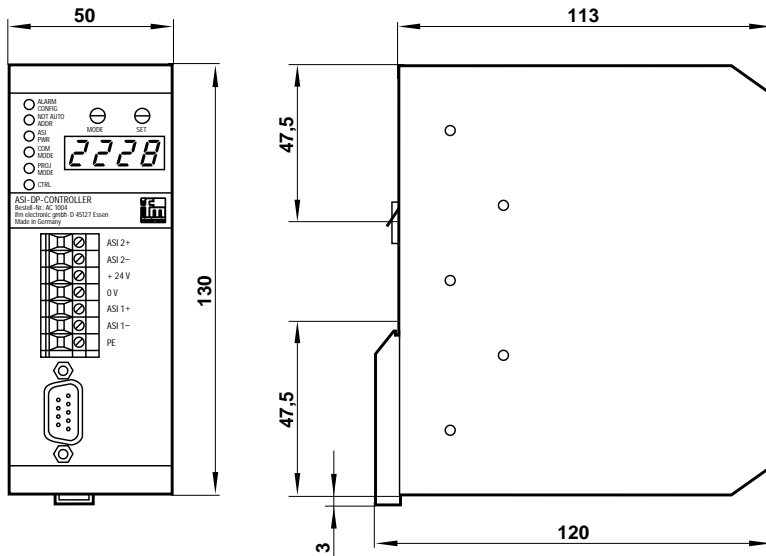

See page 6.4.010.16 for information on AS-I configuration and controller programming software.



### AS-I Master Controllers

#### Technical Specification

Description	6.1 VE1ASCT1-RS232 Controller (1 master)	6.2 VE1ASCT2-RS232 Controller (2 masters)																						
Operating voltage	10-30V d.c. (typ 24V d.c.)	10-30V d.c. (typ 24V d.c.)																						
Power consumption	≤ 10W	≤ 10W																						
Serial interfaces	RS 232 C Transm. rate 9600/19200 baud	RS 232 C Transm. rate 9600/19200 baud																						
AS-I Interfaces	To AS-I specification	To AS-I specification																						
No. of screw clamps	5	7																						
Function indicator	2 x red, green and yellow	2 x red, green and yellow																						
Control buttons	1 x MODE 1 x SET/4-digit LED	1 x MODE 1 x SET/4-digit LED																						
Ambient temperature	0°C to +70°C	0°C to +70°C																						
Housing	Clamp rail housing can mount on DIN rails	Clamp rail housing can mount on DIN rails																						
Protection class	Housing: IP20 Clamps: IP20	Housing: IP20 Clamps: IP20																						
LED Functions on Control panel	<table border="0"> <tr> <td>Red</td> <td>Configuration alarm</td> <td rowspan="10"> </td> </tr> <tr> <td>Red</td> <td>Auto addressing blocked</td> </tr> <tr> <td>Green</td> <td>AS-I power</td> </tr> <tr> <td>Green</td> <td>Normal operation</td> </tr> <tr> <td>Yellow</td> <td>Configuration</td> </tr> <tr> <td>Yellow (flashing)</td> <td>Unprotected mode</td> </tr> <tr> <td>Yellow</td> <td>Controller in RUN mode</td> </tr> </table>		Red	Configuration alarm		Red	Auto addressing blocked	Green	AS-I power	Green	Normal operation	Yellow	Configuration	Yellow (flashing)	Unprotected mode	Yellow	Controller in RUN mode							
Red	Configuration alarm																							
Red	Auto addressing blocked																							
Green	AS-I power																							
Green	Normal operation																							
Yellow	Configuration																							
Yellow (flashing)	Unprotected mode																							
Yellow	Controller in RUN mode																							
Block diagram																								
Connection schematic	<p>Clamps 6 and 7 apply only to 6.2 VE1ASCT2-RS232</p> <table border="0"> <tr> <td>7</td> <td>ASI 2+</td> <td rowspan="2">} ASI network 2 wire</td> </tr> <tr> <td>6</td> <td>ASI 2-</td> </tr> <tr> <td colspan="3">-----</td> </tr> <tr> <td>5</td> <td>+24V</td> <td rowspan="2">} operating voltage</td> </tr> <tr> <td>4</td> <td>0V</td> </tr> <tr> <td>3</td> <td>ASI 1+</td> <td rowspan="2">} ASI network 1 wire</td> </tr> <tr> <td>2</td> <td>ASI 1-</td> </tr> <tr> <td>1</td> <td>PE</td> <td>Ground</td> </tr> </table>		7	ASI 2+		} ASI network 2 wire	6	ASI 2-	-----			5	+24V	} operating voltage	4	0V	3	ASI 1+	} ASI network 1 wire	2	ASI 1-	1	PE	Ground
7	ASI 2+		} ASI network 2 wire																					
6	ASI 2-																							
-----																								
5	+24V	} operating voltage																						
4	0V																							
3	ASI 1+	} ASI network 1 wire																						
2	ASI 1-																							
1	PE	Ground																						



### Software and Handbook

VE1ASMA1-E0000 English  
VE1ASMA1-G0000 German

The Ecolog AS-I system software enables complete operation of AS-I systems.

AS-I software used for	Configuration of interface Programming controller Diagnosis/visualation of data in controller
Hardware required	IBM personal computer or compatible. Min 386 Microsoft Windows 3.1 or higher RAM memory min 4MB
Programming language	IEC-1131-3
Connection	From PC and AS-I Controller via normal serial interface (RS 323C)

### Configuration

Straight forward configuration of your AS-I network using this menu driven software.

### Programming

The powerful Ecolog software offers a wide range of features for programming of simple to highly sophisticated applications.

You can choose your favourite programming language from 4 popular options including:

- Ladder Diagram
- Function Block Diagram
- Instruction List
- Sequential Function Chart

A wide variety of functions are available including:

- Logical – AND, OR, NOT. Set/Restet, flip-flop etc.
- Comparison – GREATER/LESS THAN, EQUAL TO etc.
- Mathematical – ADD, MULTIPLY, DIVIDE etc.

### Other Features

Timers and Counters, Data Type Conversion, Bit Shifts, Arrays and Numerical Functions (SIN, COS, SQRT etc.)

The Ecolog software also offers on-screen process visualation and program simulation.

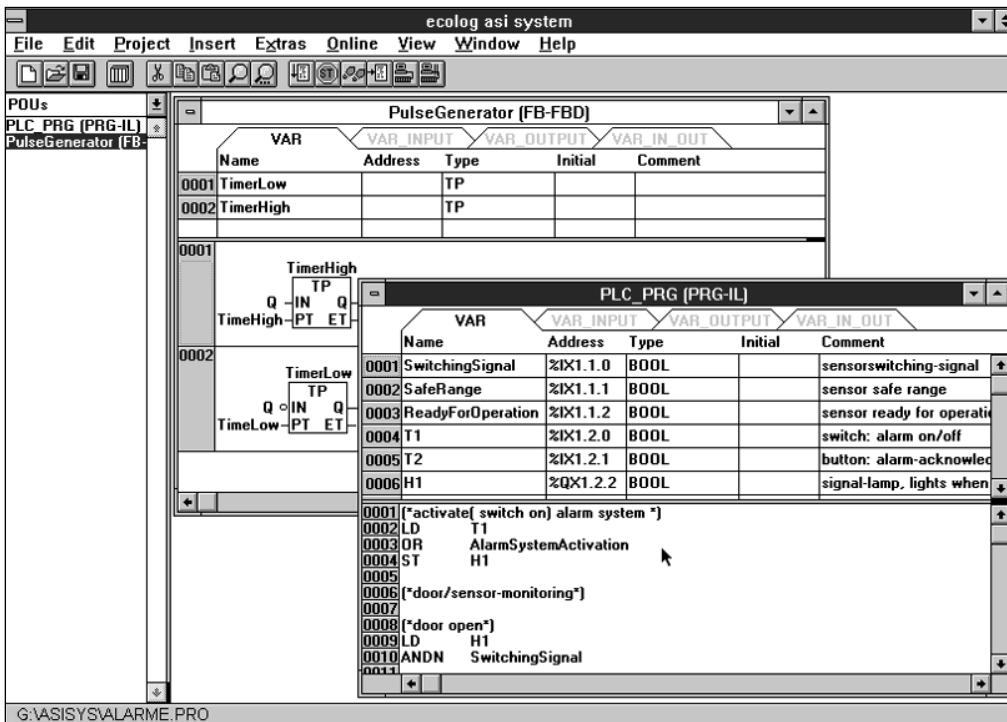





### Wireable plug for input or output cable assemblies

VE1FBCRS-M125P

Wireable 5 pin male plug – screw termination

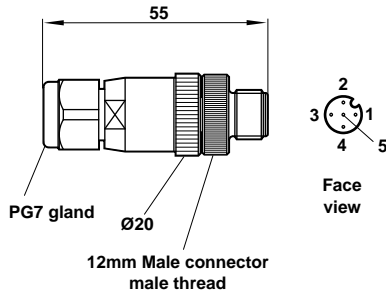

### Output M12 plug and cable assemblies for solenoid coils

VE1FBCSC-M1203

0.3m Connecting cable – 5 pin plug to valve connection  
DIN 43650 Form C (15mm)

VE1FBCSC-M1210

1m Connecting cable – 5 pin plug to valve connection  
DIN 43650 Form C (15mm)

VE1FBCSB-M1203

0,3m Connecting cable – 5 pin plug to valve connection –  
Industrial (22mm coil)

VE1FBCSB-M1210

1m Connecting cable – 5 pin plug to valve connection  
Industrial (22mm coil)

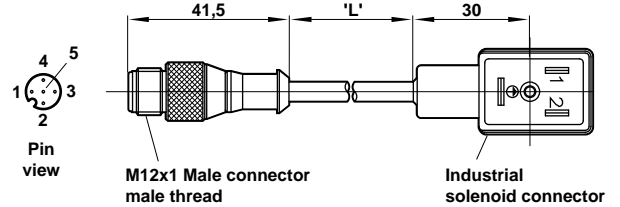
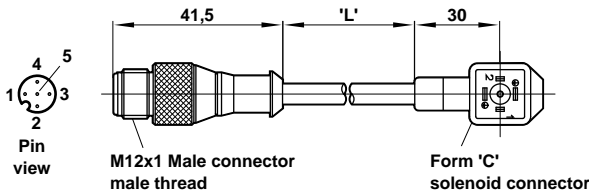

VE1FBCSA-M1203

0,3m Connecting cable – 5 pin plug to valve connection DIN  
3650 Form A (30mm coil)

VE1FBCSA-M1210

1m Connecting cable – 5 pin plug to valve connection – DIN  
3650 Form A (30mm coil)

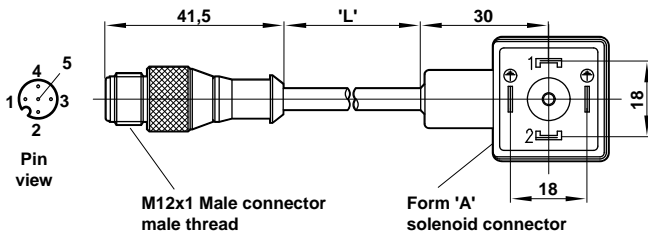



Input /sensor and drop line plug and cable assemblies

Cables with straight sensor connection

- VE1FBC8S-M1210  
1m Connecting cable – 3 pin plug M12 to 3 pin socket (Ø8)
- VE1FBC8S-M1230  
3m Connecting cable – 3 pin plug M12 to 3 pin socket (Ø8)
- VE1FBC8S-M1250  
5m Connecting cable – 3 pin plug M12 to 3 pin socket (Ø8)

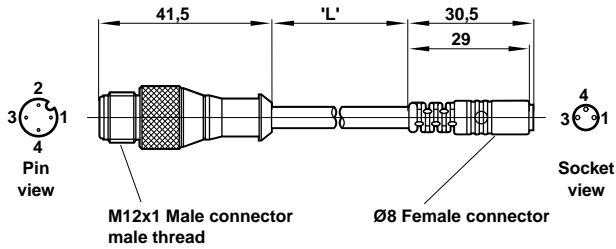

Cables with right angled sensor connection

- VE1FBC8E-M1210  
1m Connecting cable – 3 pin plug M12 to 3 pin socket (Ø8)
- VE1FBC8E-M1230  
3m Connecting cable – 3 pin plug M12 to 3 pin socket (Ø8)
- VE1FBC8E-M1250  
5m Connecting cable – 3 pin plug M12 to 3 pin socket (Ø8)

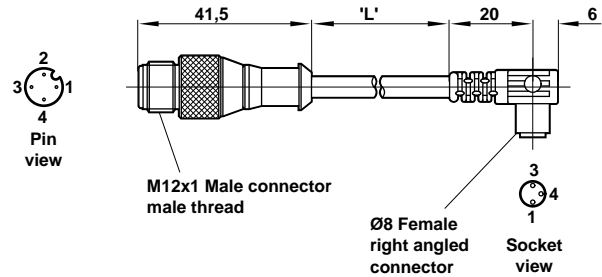

- VE1FBC0S-M1210  
Connecting cable – 4 pin plug M12 to 4 pin socket M12\*
- VE1FBC0S-M1230  
Connecting cable – 4 pin plug M12 to 4 pin socket M12\*
- VE1FBC0S-M1250  
Connecting cable – 4 pin plug M12 to 4 pin socket M12\*

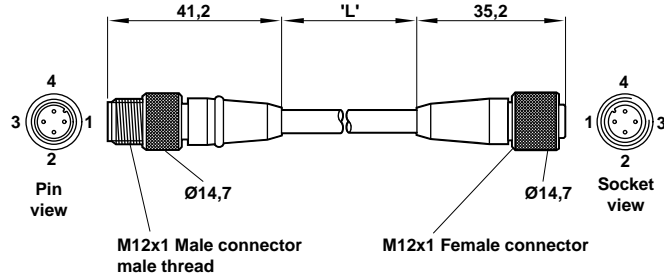

\*Can also be used for drop line connections

Tee connector

- VE1ASCN1-M1200  
Tee connector for ASI communication or power cable to M12 female

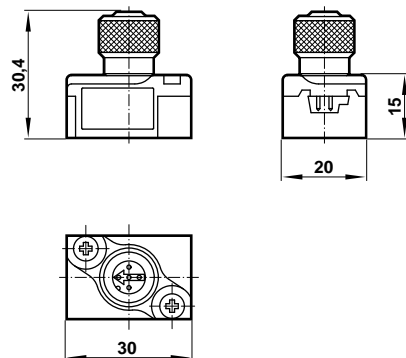

Blanking plugs

- VE1FBCBK-M1200  
Blanking plug for unused M12 connectors

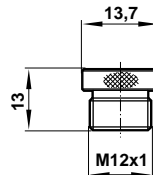



### Installation cables for AS-Interface systems

VE1ASCAY-YMXXX  
YM5 flat yellow cable\*

VE1ASCAB-YMXXX  
YM5 flat yellow cable\*

XXX = cable length in metres: 025, 075, 100

\* thermoplastic elastomer for oil resistance

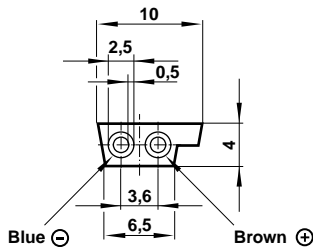

Cable clip for AS-I cable	Part Number (pack of 100)
1 cable	VE1ASAC1-CL001

### Junction box

VE1ASCN1-JB001

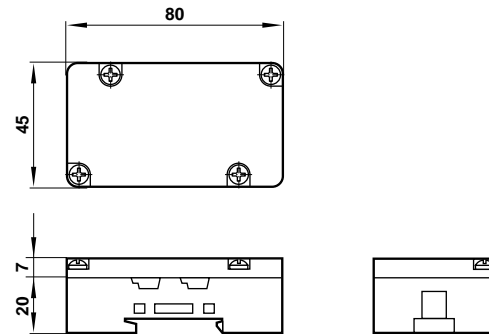

### Programming cable

VE1ASPRG-PCETL  
To connect RS-232 C coupler from AS-I Controller with PC Socket to socket sub-D 9 pin

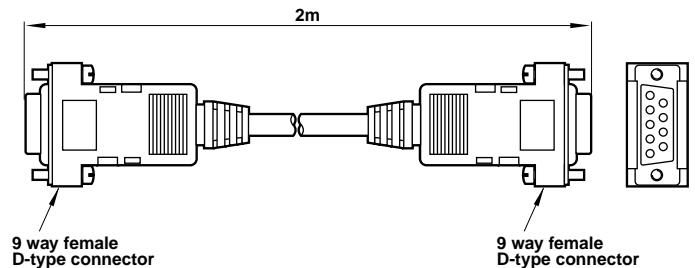

### Hand held AS-I addressing unit

VE1ASHP1-00000  
For addressing connected modules, intelligent sensors and actuators

#### Technical Specification

Battery operated	
Keyboard	<ul style="list-style-type: none"> <li> Increment slave address</li> <li> Decrement slave address</li> <li> Address slave</li> <li> Read slave/unit ON</li> </ul>

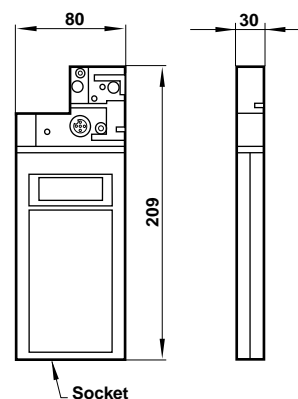

### Warning

These products are intended for use in industrial control systems only. Do not use these products where *voltage, current and temperatures* can exceed those listed under 'Technical Data'. Before using these products for non-industrial applications, life-support systems, or other applications not within published specifications, consult NORGREN.

Through misuse, age, or malfunction, components used in fluid power systems can fail in various modes. The system designer is warned to consider the failure modes of all component parts used in control systems and to provide adequate safeguards to prevent personal injury or damage to equipment in the event of such failure.

**System designers must provide a warning to end users in the system instructional manual if protection against a failure mode cannot be adequately provided.**

System designers and end users are cautioned to review specific warnings found in instruction sheets packed and shipped with these products.